

Mitsubishi Programmable Controller

MELSEC **Q** series

Channel Isolated RTD Input Module User's Manual

-Q68RD3-G
-GX Configurator-TI (SW1D5C-QTIU-E)

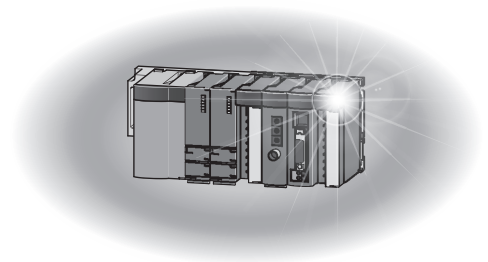

● SAFETY PRECAUTIONS ●

(Read these precautions before use.)

Before using this product, please read this manual and the relevant manuals carefully and pay full attention to safety to handle the product correctly.

In this manual, the safety precautions are classified into two levels: "⚠ WARNING" and "⚠ CAUTION".



Indicates that incorrect handling may cause hazardous conditions, resulting in death or severe injury.



Indicates that incorrect handling may cause hazardous conditions, resulting in minor or moderate injury or property damage.

Under some circumstances, failure to observe the precautions given under "⚠ CAUTION" may lead to serious consequences.

Observe the precautions of both levels because they are important for personal and system safety.

Make sure that the end users read this manual and then keep the manual in a safe place for future reference.

[Design Precautions]

⚠ WARNING

- Do not write any data to the "system area" of the buffer memory in the intelligent function module. Also, do not use any "use prohibited" signals as an output signal from the programmable controller CPU to the intelligent function module. Doing so may cause malfunction of the programmable controller system.

⚠ CAUTION

- Do not install the control lines or communication cables together with the main circuit lines or power cables. Keep a distance of 100mm or more between them. Failure to do so may result in malfunction due to noise.

[Installation Precautions]

CAUTION

- Use the programmable controller in an environment that meets the general specifications in the user's manual for the CPU module used.
Failure to do so may result in electric shock, fire, malfunction, or damage to or deterioration of the product.
- To mount the module, while pressing the module mounting lever located in the lower part of the module, fully insert the module fixing projection(s) into the hole(s) in the base unit and press the module until it snaps into place.
Incorrect mounting may cause malfunction, failure or drop of the module.
When using the programmable controller in an environment of frequent vibrations, fix the module with a screw.
- Tighten the screw within the specified torque range.
Undertightening can cause drop of the screw, short circuit or malfunction.
Overtightening can damage the screw and/or module, resulting in drop, short circuit, or malfunction.
- Shut off the external power supply (all phases) used in the system before mounting or removing the module.
Failure to do so may result in damage to the product.
A module can be replaced online (while power is on) on any MELSECNET/H remote I/O station or in the system where a CPU module supporting the online module change function is used.
Note that there are restrictions on the modules that can be replaced online, and each module has its predetermined replacement procedure.
For details, refer to the relevant chapter in this manual.
- Do not directly touch any conductive parts and electronic components of the module.
Doing so can cause malfunction or failure of the module.

[Wiring Precautions]

CAUTION

- Individually ground the shielded cables of the programmable controller with a ground resistance of 100 Ω or less.
Failure to do so may result in electric shock or malfunction.
- Connectors for external devices must be crimped or pressed with the tool specified by the manufacturer, or must be correctly soldered.
Incomplete connections may cause short circuit, fire, or malfunction.
- Prevent foreign matter such as dust or wire chips from entering the module.
Such foreign matter can cause a fire, failure, or malfunction.
- A protective film is attached to the top of the module to prevent foreign matter, such as wire chips, from entering the module during wiring.
Do not remove the film during wiring.
Remove it for heat dissipation before system operation.

[Wiring Precautions]

CAUTION

- Place the cables in a duct or clamp them.
If not, dangling cable may swing or inadvertently be pulled, resulting in damage to the module or cables or malfunction due to poor contact.
- When disconnecting the cable from the module, do not pull the cable by the cable part.
For the cable with connector, hold the connector part of the cable.
Pulling the cable connected to the module may result in malfunction or damage to the module or cable.

[Startup and Maintenance Precautions]

WARNING

- Do not touch any terminal while power is on.
Doing so will cause electric shock or malfunction.
- Shut off the external power supply (all phases) used in the system before cleaning the module or retightening the terminal screws, connector screws, or module fixing screws.
Failure to do so may result in electric shock or cause the module to fail or malfunction.
Undertightening can cause drop of the screw, short circuit or malfunction.
Overtightening can damage the screw and/or module, resulting in drop, short circuit, or malfunction.

 **CAUTION**

- Do not disassemble or modify the modules.
Doing so may cause failure, malfunction, injury, or a fire.
- Shut off the external power supply (all phases) used in the system before mounting or removing the module.
Failure to do so may cause the module to fail or malfunction.
A module can be replaced online (while power is on) on any MELSECNET/H remote I/O station or in the system where a CPU module supporting the online module change function is used.
Note that there are restrictions on the modules that can be replaced online, and each module has its predetermined replacement procedure.
For details, refer to the relevant chapter in this manual.
- After the first use of the product, do not mount/remove the module to/from the base unit more than 50 times (IEC 61131-2 compliant).
Exceeding the limit of 50 times may cause malfunction.
- Do not touch any terminal while power is on.
Failure to do so may cause malfunction.
- Shut off the external power supply (all phases) used in the system before cleaning the module or retightening the module fixing screws.
Failure to do so may cause the module to fail or malfunction.
Undertightening can cause drop of the screw, short circuit or malfunction.
Overtightening can damage the screw and/or module, resulting in drop, short circuit, or malfunction.
- Before handling the module, touch a grounded metal object to discharge the static electricity from the human body.
Failure to do so may cause the module to fail or malfunction.

[Disposal Precautions]

 **CAUTION**

- When disposing of this product, treat it as industrial waste.

● CONDITIONS OF USE FOR THE PRODUCT ●

- (1) Mitsubishi programmable controller ("the PRODUCT") shall be used in conditions;
 - i) where any problem, fault or failure occurring in the PRODUCT, if any, shall not lead to any major or serious accident; and
 - ii) where the backup and fail-safe function are systematically or automatically provided outside of the PRODUCT for the case of any problem, fault or failure occurring in the PRODUCT.

- (2) The PRODUCT has been designed and manufactured for the purpose of being used in general industries.

MITSUBISHI SHALL HAVE NO RESPONSIBILITY OR LIABILITY (INCLUDING, BUT NOT LIMITED TO ANY AND ALL RESPONSIBILITY OR LIABILITY BASED ON CONTRACT, WARRANTY, TORT, PRODUCT LIABILITY) FOR ANY INJURY OR DEATH TO PERSONS OR LOSS OR DAMAGE TO PROPERTY CAUSED BY the PRODUCT THAT ARE OPERATED OR USED IN APPLICATION NOT INTENDED OR EXCLUDED BY INSTRUCTIONS, PRECAUTIONS, OR WARNING CONTAINED IN MITSUBISHI'S USER, INSTRUCTION AND/OR SAFETY MANUALS, TECHNICAL BULLETINS AND GUIDELINES FOR the PRODUCT.

("Prohibited Application")

Prohibited Applications include, but not limited to, the use of the PRODUCT in;

- Nuclear Power Plants and any other power plants operated by Power companies, and/or any other cases in which the public could be affected if any problem or fault occurs in the PRODUCT.
- Railway companies or Public service purposes, and/or any other cases in which establishment of a special quality assurance system is required by the Purchaser or End User.
- Aircraft or Aerospace, Medical applications, Train equipment, transport equipment such as Elevator and Escalator, Incineration and Fuel devices, Vehicles, Manned transportation, Equipment for Recreation and Amusement, and Safety devices, handling of Nuclear or Hazardous Materials or Chemicals, Mining and Drilling, and/or other applications where there is a significant risk of injury to the public or property.

Notwithstanding the above, restrictions Mitsubishi may in its sole discretion, authorize use of the PRODUCT in one or more of the Prohibited Applications, provided that the usage of the PRODUCT is limited only for the specific applications agreed to by Mitsubishi and provided further that no special quality assurance or fail-safe, redundant or other safety features which exceed the general specifications of the PRODUCTS are required. For details, please contact the Mitsubishi representative in your region.

REVISIONS

* The manual number is given on the bottom left of the back cover.

Print Date	*Manual Number	Revision
Apr., 2008	SH(NA)-080722ENG-A	First edition
May, 2008	SH(NA)-080722ENG-B	<p>Correction</p> <p>SAFETY PRECAUTIONS, GENERIC TERMS, ABBREVIATIONS, AND TERMS, Section 2.1, 3.1, 4.1, 5.2.1, 5.3.1, 5.3.3, 7.1</p>
Sep., 2011	SH(NA)-080722ENG-C	<p>Correction</p> <p>SAFETY PRECAUTIONS, COMPLIANCE WITH EMC AND LOW VOLTAGE DIRECTIVES, Section 6.2.3, WARRANTY</p> <p>Addition</p> <p>CONDITIONS OF USE FOR THE PRODUCT</p>
Feb., 2012	SH(NA)-080722ENG-D	<p>Correction</p> <p>SAFETY PRECAUTIONS, COMPLIANCE WITH EMC AND LOW VOLTAGE DIRECTIVES, GENERIC TERMS, ABBREVIATIONS, AND TERMS, Chapter 1, Section 1.1, 2.1 to 2.3, 3.1, 3.2, 3.2.1 to 3.2.3, 3.3.1, 3.3.2, 3.4.1, 3.4.4, 3.4.5, 3.4.10, 3.4.11, 4.1, 4.3, 4.4.1, 4.4.2, 4.5, 4.6, 5.2.1, 5.2.2, 5.3.1, 5.4, 5.5, 5.6.1, 5.6.2, 6.2.1, 6.2.2, 7.1, 7.3.1 to 7.3.6, 7.4, 7.5, 8.1, Appendix 1.2 to 1.4, Appendix 2</p> <p>Deletion</p> <p>Appendix 1</p>
Jun., 2016	SH(NA)-080722ENG-E	<p>Correction</p> <p>GENERIC TERMS, ABBREVIATIONS, AND TERMS, Section 2.1, 2.3, 4.4.2, 5.2.1, 5.2.2, Appendix 2</p>

Japanese Manual Version SH-080721-E

This manual confers no industrial property rights or any rights of any other kind, nor does it confer any patent licenses. Mitsubishi Electric Corporation cannot be held responsible for any problems involving industrial property rights which may occur as a result of using the contents noted in this manual.

© 2008 MITSUBISHI ELECTRIC CORPORATION

INTRODUCTION

Thank you for choosing the Mitsubishi MELSEC-Q Series General Purpose Programmable Controllers. Before using the equipment, please read this manual carefully to develop full familiarity with the functions and performance of the Q series programmable controller you have purchased, so as to ensure correct use.

CONTENTS

SAFETY PRECAUTIONS	A - 1
CONDITIONS OF USE FOR THE PRODUCT.....	A - 7
REVISIONS.....	A - 8
INTRODUCTION.....	A - 9
CONTENTS	A - 9
COMPLIANCE WITH EMC AND LOW VOLTAGE DIRECTIVES.....	A - 13
GENERIC TERMS, ABBREVIATIONS, AND TERMS	A - 14
PACKING LIST	A - 15

CHAPTER1 OVERVIEW **1 - 1 to 1 - 3**

1.1 Features.....	1 - 2
-------------------	-------

CHAPTER2 SYSTEM CONFIGURATION **2 - 1 to 2 - 6**

2.1 Applicable Systems	2 - 1
2.2 When Using the Q68RD3-G in the Redundant System.....	2 - 3
2.3 How to Check the Function Version, Serial No., and Software Version	2 - 4

CHAPTER3 SPECIFICATIONS **3 - 1 to 3 - 49**

3.1 Performance Specifications	3 - 1
3.2 Function List	3 - 3
3.2.1 Temperature conversion system	3 - 4
3.2.2 Conversion setting for disconnection detection function	3 - 9
3.2.3 Warning output function.....	3 - 11
3.3 I/O Signals for Communicating with Programmable Controller CPU.....	3 - 17
3.3.1 I/O signal list.....	3 - 17
3.3.2 I/O signal details	3 - 18
3.4 Buffer Memory	3 - 24
3.4.1 Buffer memory assignment.....	3 - 24
3.4.2 Conversion enable/disable setting (Un\G0).....	3 - 30
3.4.3 CH[] Time/Count/Moving average/Time constant setting (Un\G1 to Un\G8).....	3 - 31
3.4.4 Conversion completion flag (Un\G10)	3 - 32
3.4.5 CH[] Measured temperature value (Un\G11 to Un\G18)	3 - 33
3.4.6 Error code (Un\G19).....	3 - 34
3.4.7 Setting range 1, 2 (Un\G20 and Un\G21).....	3 - 34
3.4.8 Setting range 3 (Offset/gain setting) (Un\G22).....	3 - 34

3.4.9	Averaging processing selection (Un\G24 and Un\G25).....	3 - 35
3.4.10	Offset/gain setting mode (Un\G26 and Un\G27).....	3 - 36
3.4.11	CH[] Offset/gain temperature setting values (Un\G28 to Un\G43).....	3 - 37
3.4.12	Warning output enable/disable setting (Un\G46).....	3 - 37
3.4.13	Warning output flag (Process alarm/Rate alarm) (Un\G47 and Un\G48)	3 - 38
3.4.14	Disconnection detection flag (Un\G49).....	3 - 39
3.4.15	CH[] Scaling value (Un\G50 to Un\G57).....	3 - 41
3.4.16	Scaling valid/invalid setting (Un\G58).....	3 - 42
3.4.17	CH[] Scaling range upper/lower limit values (Un\G62 to Un\G77).....	3 - 43
3.4.18	CH[] Scaling width upper/lower limit values (Un\G78 to Un\G93).....	3 - 43
3.4.19	CH[] Process alarm upper/lower limit values (Un\G94 to Un\G125).....	3 - 44
3.4.20	CH[] Rate alarm warning detection period (Un\G126 to Un\G133).....	3 - 45
3.4.21	CH[] Rate alarm upper/lower limit values (Un\G134 to Un\G149)	3 - 45
3.4.22	Mode switching setting (Un\G158 and Un\G159).....	3 - 46
3.4.23	Conversion setting for disconnection detection (Un\G164 and Un\G165).....	3 - 47
3.4.24	CH[] Conversion setting value for disconnection detection (Un\G166 to Un\G173)	3 - 48
3.4.25	Factory default offset/gain values, User range settings offset/gain values, User range settings resistance offset/gain values (Un\G190 to Un\G253)	3 - 49

CHAPTER4 PROCEDURES AND SETTINGS BEFORE SYSTEM OPERATION

4 - 1 to 4 - 16

4.1	Handling Precautions.....	4 - 1
4.1.1	Fixing module with module fixing bracket.....	4 - 2
4.2	Procedures and Settings before System Operation	4 - 3
4.3	Part Names.....	4 - 4
4.4	Wiring.....	4 - 6
4.4.1	Wiring precautions.....	4 - 6
4.4.2	External wiring	4 - 7
4.5	Intelligent Function Module Switch Setting.....	4 - 9
4.6	Offset/Gain Setting	4 - 11

CHAPTER5 UTILITY PACKAGE (GX Configurator-TI)

5 - 1 to 5 - 25

5.1	Utility Package Functions	5 - 1
5.2	Installing and Uninstalling Utility Package	5 - 3
5.2.1	Precautions for use.....	5 - 3
5.2.2	Operating environment	5 - 6
5.3	Operating Utility Package	5 - 8
5.3.1	Common operations	5 - 8
5.3.2	Operation overview.....	5 - 11
5.3.3	Activating intelligent function module utility	5 - 13
5.4	Initial Setting	5 - 15
5.5	Auto Refresh Setting.....	5 - 17
5.6	Monitor/Test.....	5 - 19
5.6.1	Monitor/test screen	5 - 19
5.6.2	Offset/gain setting operation.....	5 - 22
5.6.3	OMC (Online Module Change) refresh data	5 - 25

CHAPTER6 PROGRAMMING **6 - 1 to 6 - 31**

6.1	Programming Procedure.....	6 - 2
6.2	Using Programs in Normal System Configuration	6 - 4
6.2.1	Before creating a program.....	6 - 6
6.2.2	Program example when utility package is used	6 - 8
6.2.3	Program example when utility package is not used	6 - 13
6.3	Using Programs on Remote I/O Network	6 - 18
6.3.1	Before creating a program.....	6 - 20
6.3.2	Program example when utility package is used	6 - 21
6.3.3	Program example when utility package is not used	6 - 25

CHAPTER7 ONLINE MODULE CHANGE **7 - 1 to 7 - 37**

7.1	Conditions Required for Online Module Change	7 - 2
7.2	Operations during Online Module Change	7 - 3
7.3	Procedures of Online Module Change.....	7 - 4
7.3.1	When factory default is used and initial setting has been made with GX Configurator-TI.....	7 - 4
7.3.2	When factory default is used and initial setting has been made with sequence program	7 - 9
7.3.3	When user range setting is used and initial setting has been made with GX Configurator-TI (Separate system is available)	7 - 13
7.3.4	When user range setting is used and initial setting has been made with GX Configurator-TI (Separate system is not available)	7 - 18
7.3.5	When user range setting is used and initial setting has been made with sequence program (Separate system is available)	7 - 24
7.3.6	When user range setting is used and initial setting has been made with sequence program (Separate system is not available)	7 - 29
7.4	Range Reference Table.....	7 - 34
7.5	Precautions for Online Module Change.....	7 - 37

CHAPTER8 TROUBLESHOOTING **8 - 1 to 8 - 7**

8.1	Error Code List.....	8 - 1
8.2	Troubleshooting	8 - 3
8.2.1	When "RUN" LED turns off.....	8 - 3
8.2.2	When "RUN" LED flashes	8 - 3
8.2.3	When "ERR" LED flashes.....	8 - 3
8.2.4	When "ERR" LED turns on	8 - 3
8.2.5	When "ALM" LED flashes.....	8 - 4
8.2.6	When "ALM" LED turns on	8 - 4
8.2.7	When Disconnection detection signal (XC) turns ON	8 - 4
8.2.8	When measured temperature value cannot be read	8 - 4
8.2.9	When measured temperature value is abnormal.....	8 - 5
8.2.10	Checking Q68RD3-G status using system monitor of GX Developer	8 - 6

APPENDICES **APPX - 1 to APPX - 13**

Appendix 1	Dedicated Instructions	APPX - 1
Appendix 1.1	List of Dedicated Instructions and Available Devices	APPX - 1

Appendix 1.2	G(P).OFFGAN	APPX - 2
Appendix 1.3	G(P).OGLOAD	APPX - 4
Appendix 1.4	G(P).OGSTOR	APPX - 8
Appendix 2	External Dimensions	APPX - 13

INDEX**INDEX - 1 to INDEX - 2**

COMPLIANCE WITH EMC AND LOW VOLTAGE DIRECTIVES

(1) Method of ensuring compliance

To ensure that Mitsubishi programmable controllers maintain EMC and Low Voltage Directives when incorporated into other machinery or equipment, certain measures may be necessary. Please refer to one of the following manuals.

- QCPU User's Manual (Hardware Design, Maintenance and Inspection)
- Safety Guidelines

(This manual is included with the CPU module or base unit.)

The CE mark on the side of the programmable controller indicates compliance with EMC and Low Voltage Directives.

(2) Additional measures

To ensure that this product maintains EMC and Low Voltage Directives, please refer to Section 4.4.1.

GENERIC TERMS, ABBREVIATIONS, AND TERMS

Unless otherwise specified, this manual uses the following general terms, abbreviations, and terms.

Generic term/ Abbreviation/Term	Description
Q68RD3-G	The abbreviation for the Q68RD3-G channel isolated RTD input module
Up scale	A measurement range maximum value + 5% of the measurement range
Down scale	A measurement range minimum value - 5% of the measurement range
GX Developer	The product name of the software package for the MELSEC programmable controllers
GX Works2	
GX Configurator-TI	The abbreviation for the thermocouple input module setting and monitor tool GX Configurator-TI (SW1D5C-QTIU-E)
QCPU (Q mode)	A generic term for the Q00JCPU, Q00CPU, Q01CPU, Q02CPU, Q02HCPU, Q06HCPU, Q12HCPU, Q25HCPU, Q02PHCPU, Q06PHCPU, Q12PHCPU, Q25PHCPU, Q12PRHCPU, Q25PRHCPU, Q00JUCPU, Q00UCPU, Q01UCPU, Q02UCPU, Q03UDCPU, Q04UDHCPU, Q06UDHCPU, Q10UDHCPU, Q13UDHCPU, Q20UDHCPU, Q26UDHCPU, Q03UDECPU, Q04UDEHCPU, Q06UDEHCPU, Q10UDEHCPU, Q13UDEHCPU, Q20UDEHCPU, Q26UDEHCPU, Q50UDEHCPU, and Q100UDEHCPU
Process CPU	A generic term for the Q02PHCPU, Q06PHCPU, Q12PHCPU, and Q25PHCPU
Redundant CPU	A generic term for the Q12PRHCPU and Q25PRHCPU
Personal computer	An IBM PC/AT [®] or compatible computer with DOS/V
RTD (Resistance Temperature Detector)	A generic term for the platinum RTD and nickel RTD
Windows Vista [®]	A generic term for the following: Microsoft [®] Windows Vista [®] Home Basic Operating System, Microsoft [®] Windows Vista [®] Home Premium Operating System, Microsoft [®] Windows Vista [®] Business Operating System, Microsoft [®] Windows Vista [®] Ultimate Operating System, Microsoft [®] Windows Vista [®] Enterprise Operating System
Windows [®] XP	A generic term for the following: Microsoft [®] Windows [®] XP Professional Operating System, Microsoft [®] Windows [®] XP Home Edition Operating System
Windows [®] 7	A generic term for the following: Microsoft [®] Windows [®] 7 Starter Operating System, Microsoft [®] Windows [®] 7 Home Premium Operating System, Microsoft [®] Windows [®] 7 Professional Operating System, Microsoft [®] Windows [®] 7 Ultimate Operating System, Microsoft [®] Windows [®] 7 Enterprise Operating System Note that the 32-bit version is designated as "32-bit Windows [®] 7", and the 64-bit version is designated as "64-bit Windows [®] 7".

PACKING LIST

The product package contains the following.

Model	Product	Quantity
Q68RD3-G	Q68RD3-G channel isolated RTD input module	1
SW1D5C-QTIU-E	GX Configurator-TI Version1 (Single license product) (CD-ROM)	1
SW1D5C-QTIU-EA	GX Configurator-TI Version1 (Volume license product) (CD-ROM)	1

CHAPTER1 OVERVIEW

This user's manual provides the specifications, handling instructions, programming procedures, and other information of the Q68RD3-G channel isolated RTD (Resistance Temperature Detector) input module (hereinafter the "Q68RD3-G"), which is designed to use with the MELSEC-Q series CPU module.

The Q68RD3-G is a RTD module (3-wire type) and converts temperature data [°C] input from the Pt100 or JPt100 platinum RTDs (hereinafter the "Pt100" or "JPt100") or the Ni100 nickel RTD (hereinafter the "Ni100") to measured temperature values in 16-bit signed binary data (stored as a value rounded off to one decimal place × 10) or scaling values (ratios (%)).

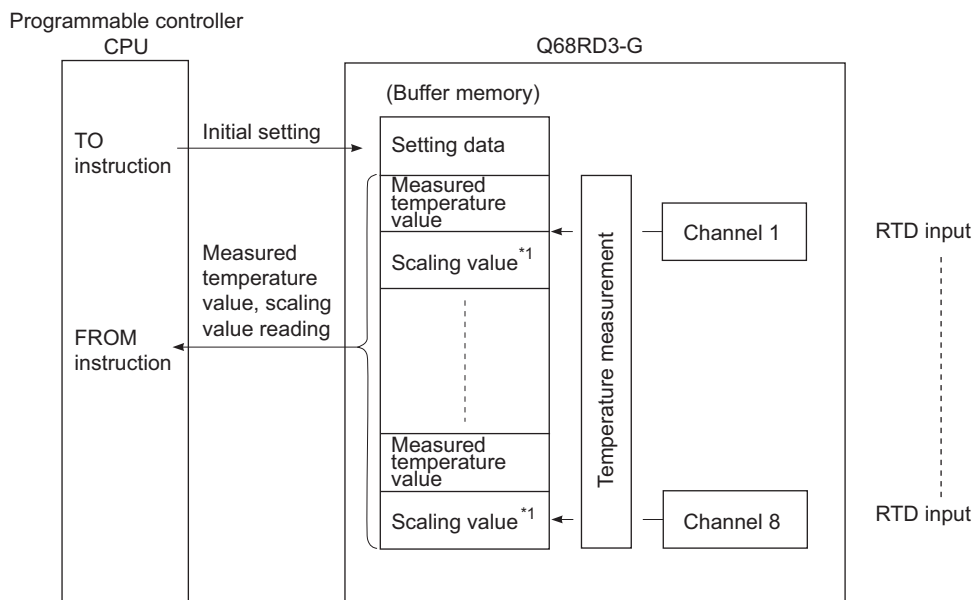

* For details on scaling values, refer to Section 3.4.15.

1.1 Features

(1) Isolated channels

The Q68RD3-G is a channel isolated module.

(2) Temperature measurement of eight channels available in one module

The Q68RD3-G can measure temperature of eight channels in one module.

The module can also convert the detected measured temperature values into scaling values (ratios (%)).

(3) Conversion enable/disable setting

Conversion enable/disable setting is possible for each channel. Disabling conversion for unused channels prevents unnecessary disconnection detection.

(4) Use of 3-wire RTDs conforming to standards

3-wire RTDs listed in the table below can be used.

Table 1.1 Available RTD

RTD		Compliant standard
Platinum RTD	Pt100	JIS C 1604-1997, IEC 751 1983
	JPt100	JIS C 1604-1981
Nickel RTD	Ni100	DIN 43760 1987

Also, RTD type and measurement range can be set for each channel using GX Developer.

(5) Disconnection detection

Disconnection status of RTD can be detected for each channel by Disconnection detection flag.

Disconnection status can also be detected from the measured temperature value by setting "Up scale", "Down scale" or "Given value" for the Conversion setting for disconnection detection.

(6) Selection of sampling processing, time average processing, count average processing, moving average processing, and primary delay filter

A temperature conversion system: sampling processing, time average processing, count average processing, moving average or primary delay filter can be selected for each channel.

(7) Error compensation by offset/gain value setting

Error compensation is available by setting offset/gain values for each channel.

Offset/gain values can be selected from user range setting and factory default setting.

(8) Warning output function**(a) Process alarm warning output**

A warning can be output when the measured temperature value exceeds the input range set by user.

Upper limit value and lower limit value can be set for each channel, and a setting to have a difference (hysteresis) between warning output and warning clear is also available.

(b) Rate alarm warning output

A warning can be output when the measured temperature value exceeds the rate of temperature change set by user.

(9) Online module change

The module can be changed without stopping the system.

Furthermore, the following operations can be processed by using sequence programs.

- Transferring the offset/gain set values to the replacement Q68RD3-G
- Transferring the offset/and gain set values to another Q68RD3-G mounted on the other slot

(10) Easy settings using GX Configurator-TI

Using GX Configurator-TI which is sold separately, sequence programs can be reduced since settings of the Q68RD3-G can be made on the screen.

Also, the set status or operating status of the module can be checked easily.

CHAPTER2 SYSTEM CONFIGURATION

This chapter explains the system configuration of the Q68RD3-G.

2.1 Applicable Systems

This section describes the applicable systems.

(1) Applicable modules and base units, and number of modules

(a) When mounted with CPU module

For the CPU modules, the number of modules, and base units applicable to the Q68RD3-G, refer to the user's manual for the CPU module used.

Note the following when the Q68RD3-G is mounted with a CPU module.

- Depending on the combination with other modules or the number of mounted modules, power supply capacity may be insufficient. Pay attention to the power supply capacity before mounting modules, and if the power supply capacity is insufficient, change the combination of the modules.
- Mount a module within the number of I/O points for the CPU module. If the number of slots is within the available range, the module can be mounted on any slot.

Remark

To use the Q68RD3-G with a C Controller module, refer to the user's manual for the C Controller module.

(b) When the module is used in a MELSECNET/H remote I/O station

For the MELSECNET/H remote I/O station, the number of modules, and base units applicable to the Q68RD3-G, refer to the Q Corresponding MELSECNET/H Network System Reference Manual (Remote I/O network).

(2) Support of multiple CPU system

When using the Q68RD3-G in a multiple CPU system, refer to the following manual first.

- QCPU User's Manual (Multiple CPU System)

(3) Support of online module change

The function version of the Q68RD3-G has been "C" from the first release, supporting online module change.

For details, refer to CHAPTER 7.

(4) Supported software packages

Relation between the system containing the Q68RD3-G and software package is shown in the following table.

GX Developer or GX Works2 is required to use the Q68RD3-G.

Table 2.1 System and compatible software package

System		Software version		
		GX Developer	GX Configurator-TI	GX Works2
Q00J/Q00/Q01CPU	Single CPU system	Version 7 or later	Version 1.26AC or later	Refer to the GX Works2 Version 1 Operating Manual (Common).
	Multiple CPU system	Version 8 or later		
Q02/Q02H/Q06H/Q12H/Q25HCPU	Single CPU system	Version 4 or later		
	Multiple CPU system	Version 6 or later		
Q02PH/Q06PHCPU	Single CPU system	Version 8.68W or later		
	Multiple CPU system			
Q12PH/Q25PHCPU	Single CPU system	Version 7.10L or later		
	Multiple CPU system			
Q12PRH/Q25PRHCPU	Redundant system	Version 8.45X or later		
Q00UJ/Q00U/Q01UCPU	Single CPU system	Version 8.76E or later		
	Multiple CPU system			
Q02U/Q03UD/Q04UDH/Q06UDHCPU	Single CPU system	Version 8.48A or later		
	Multiple CPU system			
Q10UDH/Q20UDHCPU	Single CPU system	Version 8.76E or later		
	Multiple CPU system			
Q13UDH/Q26UDHCPU	Single CPU system	Version 8.62Q or later		
	Multiple CPU system			
Q03UDE/Q04UDEH/Q06UDEH/Q13UDEH/Q26UDEHCPU	Single CPU system	Version 8.68W or later		
	Multiple CPU system			
Q10UDEH/Q20UDEHCPU	Single CPU system	Version 8.76E or later		
	Multiple CPU system			
CPU modules other than the above	Single CPU system	Cannot be used	Cannot be used	
	Multiple CPU system			
When mounted to MELSECNET/H remote I/O station		Version 6 or later	Version 1.26AC or later	

POINT

When using GX Works2, refer to the following:

- GX Works2 Version 1 Operating Manual (Common)
- GX Works2 Version 1 Operating Manual (Intelligent Function Module)

2.2 When Using the Q68RD3-G in the Redundant System

This section describes the use of the Q68RD3-G in the redundant system.

(1) Dedicated instructions

Dedicated instructions cannot be used.

(2) GX Configurator-TI

GX Configurator-TI cannot be used when accessing Redundant CPU via an intelligent function module on an extension base unit from GX Developer. Connect a personal computer with a communication path indicated below.

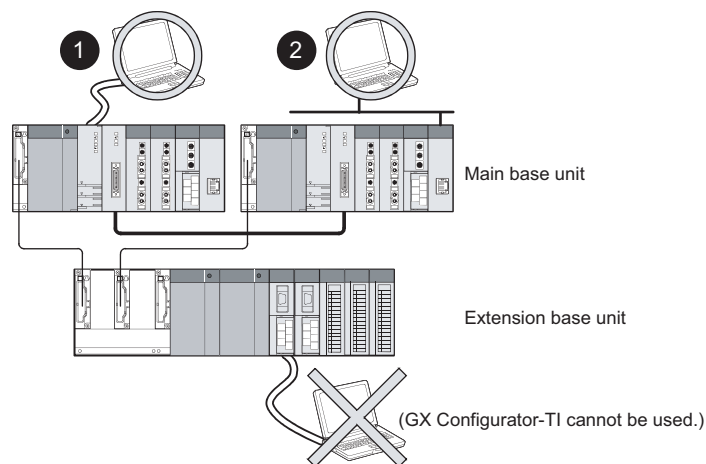

- 1 Connecting directly to a programmable controller CPU
- 2 Connecting to a programmable controller CPU via an intelligent function module (Ethernet module, MELSECNET/H module or CC-Link module) on the main base unit

Figure 2.1 Communication path for GX Configurator-TI

2.3 How to Check the Function Version, Serial No., and Software Version

(1) Checking the function version and serial No.

The serial No. and function version of the Q68RD3-G can be checked on the rating plate, front of the module, and system monitor of GX developer.

(a) On the rating plate

The rating plate is put on the side of the Q68RD3-G.

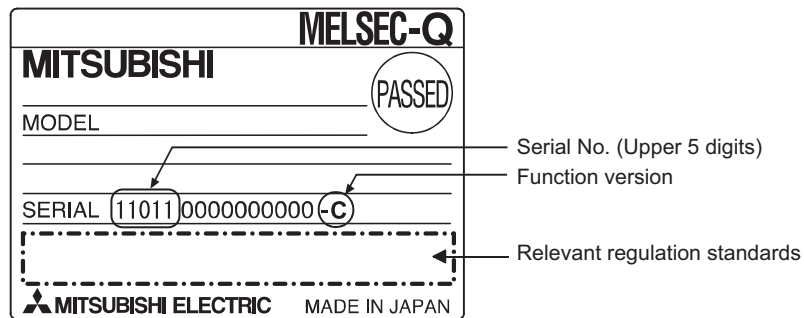

(b) On the front of the module

The function version and serial No. on the rating plate is also indicated on the front of the module (lower part).

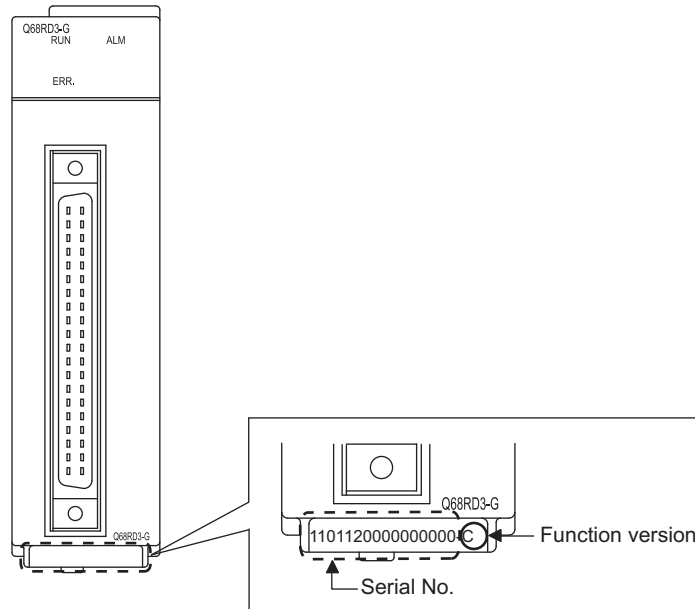

- (c) On the system monitor (product information list)
 To display the system monitor, select [Diagnostics] → [System monitor] → **Product Inf. List** of GX Developer.

Slot	Type	Series	Model name	Points	I/O No.	Master PLC	Serial No.	Ver.	Product No.
PLC	PLC	Q	Q02UCPU	-	-	-	130220000000000	B	091012092915091-B
0-0	Intelli.	Q	Q68RD3-G	16pt	0000	-	100210000000000	C	-
0-1	-	-	None	-	-	-	-	-	-
0-2	-	-	None	-	-	-	-	-	-
0-3	-	-	None	-	-	-	-	-	-

- 1) Displaying the product No.
 Since the Q68RD3-G do not support the production number display, "-" is displayed in the "Product No." field.

POINT

The serial No. on the rating plate and the front of the module may be different from the serial No.

- The serial No. on the rating plate and the front of the module indicates the management information of the product.
- The serial No. displayed on the product information list in GX Developer indicates the function information of the product. The function information of the product is updated when a new function is added.

(2) Checking the software version of GX Configurator-TI

The software version of GX Configurator-TI can be checked on GX Developer by clicking [Help] → [Product information].

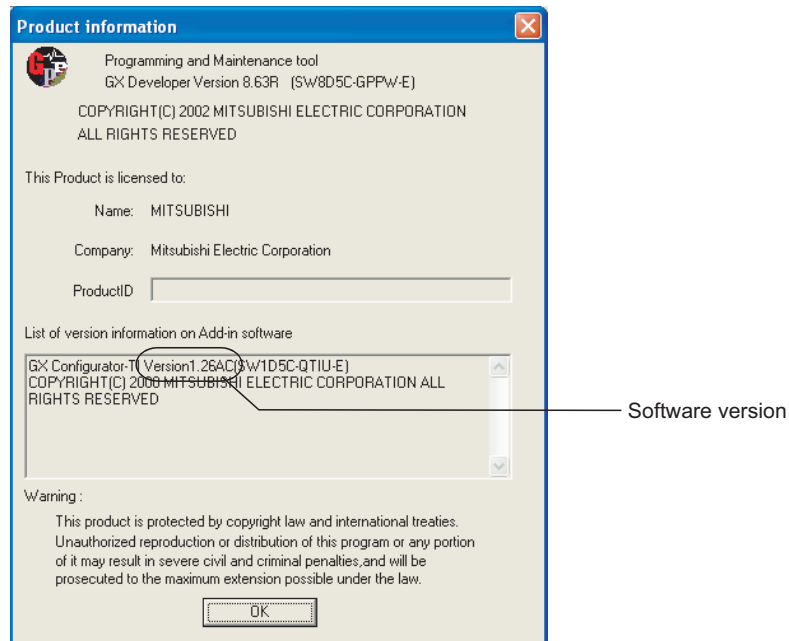

("Product information" screen of GX Developer Version 8)

CHAPTER3 SPECIFICATIONS

3.1 Performance Specifications

The following table shows the performance specifications of the Q68RD3-G.

(1) List of performance specifications

Table 3.1 List of performance specifications

Item		Specifications												
Number of channels		8 channels												
Output	Measured temperature value	16-bit signed binary (-2000 to 8500)												
	Scaling value	16-bit signed binary												
Usable RTD ^{*5}		Pt100 (JIS C 1604-1997, IEC 751 1983), JPt100 (JIS C 1604-1981), Ni100 (DIN 43760 1987)												
Measured temperature range	Pt100	-200 to 850°C												
	JPt100	-180 to 600°C												
	Ni100	-60 to 180°C												
Temperature detecting output current		1.0mA or less												
Conversion accuracy ^{*2}	Pt100	-200 to 850°C ^{*1}	± 0.8°C (Ambient temperature: 25±5°C), ± 2.4°C (Ambient temperature: 0 to 55°C)											
		-20 to 120°C ^{*1}	± 0.3°C (Ambient temperature: 25±5°C), ± 1.1°C (Ambient temperature: 0 to 55°C)											
		0 to 200°C ^{*1}	± 0.4°C (Ambient temperature: 25±5°C), ± 1.2°C (Ambient temperature: 0 to 55°C)											
	JPt100	-180 to 600°C ^{*1}	± 0.8°C (Ambient temperature: 25±5°C), ± 2.4°C (Ambient temperature: 0 to 55°C)											
		-20 to 120°C ^{*1}	± 0.3°C (Ambient temperature: 25±5°C), ± 1.1°C (Ambient temperature: 0 to 55°C)											
		0 to 200°C ^{*1}	± 0.4°C (Ambient temperature: 25±5°C), ± 1.2°C (Ambient temperature: 0 to 55°C)											
Ni100	-60 to 180°C ^{*1}	± 0.4°C (Ambient temperature: 25±5°C), ± 1.2°C (Ambient temperature: 0 to 55°C)												
Resolution		0.1°C												
Conversion speed		320ms/8 channels ^{*3}												
Number of analog input channels		8 channels												
Isolation specifications		<table border="1"> <thead> <tr> <th>Specific isolated area</th> <th>Isolation method</th> <th>Dielectric withstand voltage</th> <th>Isolation resistance</th> </tr> </thead> <tbody> <tr> <td>Between RTD input and programmable controller power supply</td> <td>Transformer isolation</td> <td>500VACrms for 1min.</td> <td rowspan="2">500VDC 10MΩ or more</td> </tr> <tr> <td>Between RTD input channels</td> <td>Transformer isolation</td> <td>1000VACrms for 1min.</td> </tr> </tbody> </table>	Specific isolated area	Isolation method	Dielectric withstand voltage	Isolation resistance	Between RTD input and programmable controller power supply	Transformer isolation	500VACrms for 1min.	500VDC 10MΩ or more	Between RTD input channels	Transformer isolation	1000VACrms for 1min.	
		Specific isolated area	Isolation method	Dielectric withstand voltage	Isolation resistance									
Between RTD input and programmable controller power supply	Transformer isolation	500VACrms for 1min.	500VDC 10MΩ or more											
Between RTD input channels	Transformer isolation	1000VACrms for 1min.												
Disconnection detection		Available (each channel respectively) ^{*4}												
Maximum number of writes to Flash memory		50,000												
Number of I/O points occupied		16 points (I/O assignment: Intelligent 16 points)												
External interface		40-pin connector												
Applicable wire size		0.3mm ² (22 AWG) or less (for A6CON1, A6CON4) 0.088mm ² to 0.24mm ² (28 to 24 AWG) (for A6CON2)												
External device connector (sold separately)		A6CON1,A6CON2,A6CON4												
Internal current consumption (5VDC)		0.54A												
Weight		0.20kg												
External dimensions		102(H)×27.4(W)×130(D)mm												

* 1 If the temperature out of the measurement range given in the table is input from the RTD, the maximum and minimum values of the measurement range are used.

* 2 When a RTD is connected, the degree of accuracy will be the sum of the conversion accuracy of the Q68RD3-G and the tolerance of the connected RTD.

Use the calculation formula below.

$$(\text{Accuracy}) = (\text{Conversion accuracy}) + (\text{Tolerance of connected RTD})$$

Table 3.2 Pt100 Tolerance (JIS C 1604-1997, IEC 751 1983)

Class	Tolerance
A	$\pm (0.15 + 0.002 t) ^\circ\text{C}$
B	$\pm (0.3 + 0.005 t) ^\circ\text{C}$

Table 3.3 JPt100 Tolerance (JIS C 1604-1981)

Class	Tolerance
0.15	$\pm (0.15 + 0.0015 t) ^\circ\text{C}$
0.2	$\pm (0.15 + 0.002 t) ^\circ\text{C}$
0.5	$\pm (0.3 + 0.005 t) ^\circ\text{C}$

Table 3.4 Ni100 Tolerance (DIN 43760 1987)

Class	Tolerance
0 to 250°C	$\pm (0.4 + 0.007 t) ^\circ\text{C}$
-60 to 0°C	$\pm (0.4 + 0.0028 t) ^\circ\text{C}$

Example 1 Ambient temperature: 40°C (for Pt100 (-200 to 850°C))

RTD type: Pt100 Class A

Measurement temperature: 800°C

$$(\text{Accuracy}) = (\pm 2.4^\circ\text{C}) + \{\pm (0.15^\circ\text{C} + 0.002 \times 800^\circ\text{C})\} = \pm 4.15^\circ\text{C}$$

Conversion accuracy with ambient temperature at 40°C

Tolerance of Pt100 with measured temperature of RTD class A at 800°C

Example 2 Ambient temperature: 25°C (for Pt100 (-200 to 850°C))

RTD type: Pt100 Class B

Measurement temperature: 500°C

$$(\text{Accuracy}) = (\pm 0.8^\circ\text{C}) + \{\pm (0.3^\circ\text{C} + 0.005 \times 500^\circ\text{C})\} = \pm 3.6^\circ\text{C}$$

Conversion accuracy with ambient temperature at 25°C

Tolerance of Pt100 with measured temperature of RTD class B at 500°C

* 3 The conversion speed indicates the time required before the measured temperature values are stored into the buffer memory when sampling processing is specified.

Regardless of the number of conversion-enabled channels, the measured temperature values of all channels are batch-stored into the buffer memory every 320ms. (Refer to Section 3.2.1.)

* 4 When disconnection state is detected, output values are selected from "Up scale", "Down scale" or "Given value". (Refer to Section 3.2.2.)

* 5 Only 3-wire RTDs can be used.

2-wire RTDs and 4-wire RTDs cannot be used.

3.2 Function List

The following table lists the Q68RD3-G functions.

Table 3.5 Function list

Item	Description	Reference
Temperature conversion function	This function incorporates temperature data to a module by connecting a RTD. Temperature data are stored into the buffer memory in 16-bit signed binary (-2000 to 8500).	Section 3.4.5
Temperature conversion system	<ul style="list-style-type: none"> (1) Sampling processing This processing converts every temperature input value for each channel and outputs a measured temperature value after every conversion. (2) Averaging processing <ul style="list-style-type: none"> (a) Time average This processing averages temperature conversion by time for each channel and stores the averaged value. (b) Count average This processing averages temperature conversion by count for each channel and stores the averaged value. (c) Moving average This processing averages measured temperature values, which are measured every sampling period for the specified number of times. (3) Primary delay filter This processing smooths measured temperature values by a preset time constant. 	Section 3.2.1
Conversion enable/disable function	This function specifies temperature conversion availability (enable or disable) for each channel. Conversion time is 320ms/8 channels.	Section 3.4.2
RTD type selection function, Range switching function	This function sets RTD type and measurement range for each channel.	Section 4.5
Disconnection detection function	This function detects disconnection of RTD which is connected to each conversion-enabled channel.	Section 3.4.14
Conversion setting for disconnection detection function	This function is to select a value to be stored in the CH□ Measured temperature value (Un\G11 to Un\G18) from "Up scale", "Down scale" or "Given value" when disconnection is detected.	Section 3.2.2
Warning output function	<ul style="list-style-type: none"> (1) Process alarm A warning is output when the measured temperature value is equal to or more than the process alarm upper upper limit value, or equal to or less than the process alarm lower lower limit value. (2) Rate alarm A warning is output when the measured temperature value changes in a rate by which the measured temperature value reaches the rate alarm upper limit value or more, or the rate alarm lower limit value or less. 	Section 3.2.3
Scaling function	This function converts measured temperature value to scaling value (ratio (%)) and stores the converted value into the buffer memory.	Section 3.4.15 to Section 3.4.18
Offset/gain setting function	This function compensates an error of measured temperature value.	Section 3.4.11 Section 4.6
Online module change	This function enables a module change without the system being stopped.	CHAPTER 7

3.2.1 Temperature conversion system

The following shows the temperature measurement timing within each conversion period. Temperatures of all channels, CH1 to CH8, are batch-updated every 320ms, regardless of the Conversion enable/disable setting (Un\G0).

If the Conversion enable/disable setting (Un\G0) of a channel is set to "Enable" when the temperature is measured, the measured temperature value is stored in the CH□ Measured temperature value (Un\G11 to Un\G18). If the setting is set to "Disable", the measured temperature value is not stored.

Regardless of the number of conversion-enabled channels, the measured temperature values are stored in the buffer memory every 320ms.

The following shows the temperature measurement timing within each conversion period.

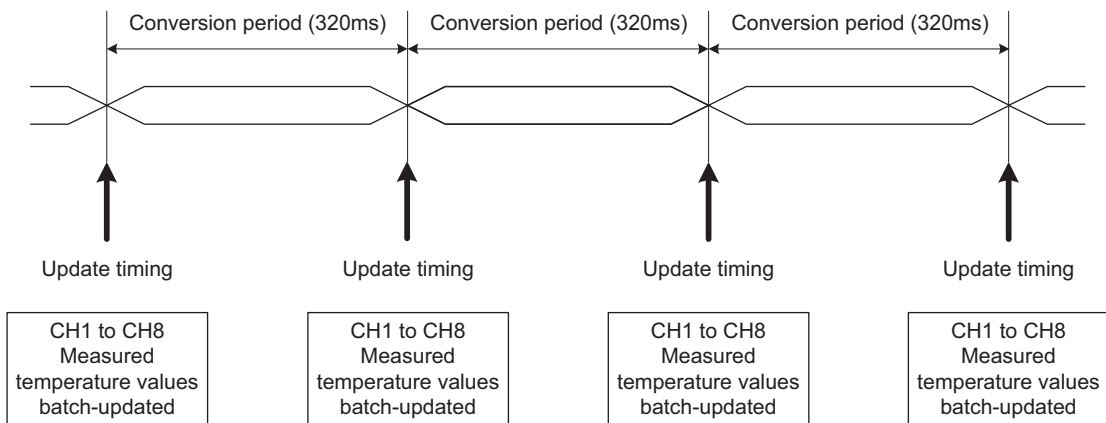

(1) Sampling processing

Measured temperature values that are measured every 320ms of sampling period are stored in the buffer memory.

(2) Averaging processing

After the first averaging processing is completed, the corresponding bit for a channel where processing has been completed of the Conversion completion flag (Un\G10) turns ON (changes to "1").

(a) Time average

Conversion is performed for a set period of time. Then, the total value, excluding the maximum and the minimum values, is averaged and the averaged value is stored in the buffer memory.

The number of processing times within the set period of time is calculated in the following formula.

$$\text{Number of processing times} = \text{set period of time} \div 320 \text{ (times)}$$

Setting range of time average is 1280 to 5000ms.

If a value outside the setting range is set, an error (error code: 20□) occurs.

[Example]

When six channels, channels 1, 2, 3, 4, 5, and 6, are conversion-enabled and the average time is set to 2000ms, temperature is measured six times and the averaged value is output.

$$2000 \div 320 = 6.25 \text{ (times)} \dots \text{ Drop the fractional part}$$

(b) Count average

Conversion is performed for a preset number of times. Then, the total value, excluding the maximum and the minimum values, is averaged and the averaged value is stored in the buffer memory.

The processing time is calculated in the following formula.

$$\text{Processing time} = \text{preset count} \times 320 \text{ (ms)}$$

Setting range of count average is 4 to 500 times.

If a value outside the setting range is set, an error (error code: 30□) occurs.

[Example]

When six channels, channels 1, 2, 3, 4, 5, and 6, are conversion-enabled and the average count is set to 5 times, the averaged value is output every 1600ms.

$$5 \times 320 = 1600 \text{ (ms)}$$

(c) Moving average

Measured temperature values, which are measured every sampling period for the specified number of times, are averaged and the averaged value is stored in the buffer memory.

The latest measured temperature value can be obtained since averaging processing is performed moving for each sampling period.

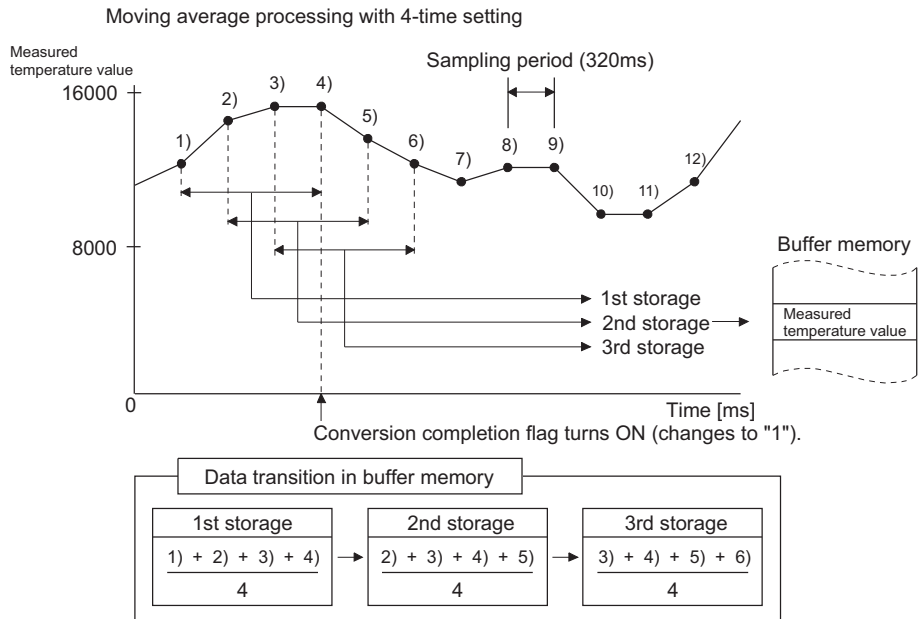

(3) Primary delay filter

By a preset time constant, measured temperature value whose transient noise has been smoothed is output.

The degree of smoothness depends on the time constant.

Time constant is the time required for measured temperature value to reach 63.2% of a steady-state value.

The relational expression between time constant and measured temperature value is shown below.

[When $n=1$ *1]

$$Y_n = 0$$

[When $n=2$]

$$Y_n = y_{n-1} + \frac{\Delta t}{\Delta t + TA} (y_n - y_{n-1})$$

[When $n \geq 3$]

$$Y_n = Y_{n-1} + \frac{\Delta t}{\Delta t + TA} (y_n - Y_{n-1})$$

Y_n : Current measured temperature value

Y_{n-1} : Preceding measured temperature value

n : Number of sampling times

TA : Time constant (320 to 5000ms)

y_n : Measured temperature value before smoothed

y_{n-1} : Preceding measured temperature value before smoothed

Δt : Conversion period (320ms)

* 1 Conversion completion flag turns ON (changes to "1") when $n \geq 2$.

Setting range of time constant is 320 to 5000ms.

If a value outside the setting range is set, an error (error code: 32□) occurs.

[Example 1: Measured temperature value when the temperature input value is changed from 250.0°C to 260.0°C]

The measured temperature value changes as shown below when the time constant is set to 3200ms (3.2s).

The measured temperature value reaches 63.2% (256.3°C) of the value converted with sampling processing in 3200ms (3.2s) after the temperature input value has reached to 260.0°C.

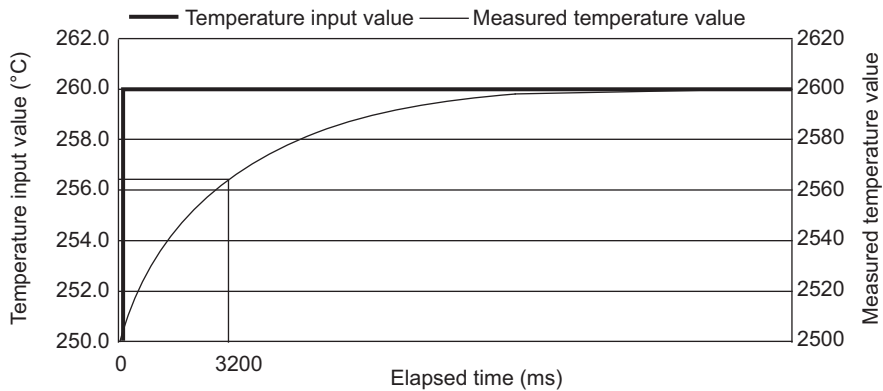

[Example 2: Measured temperature value when the change of temperature input value is a waveform with ringing]

The measured temperature value changes as shown below when the time constant is set to 1280ms (1.28s) or 640ms (0.64s), and the moving average processing is set to 4 times, respectively.

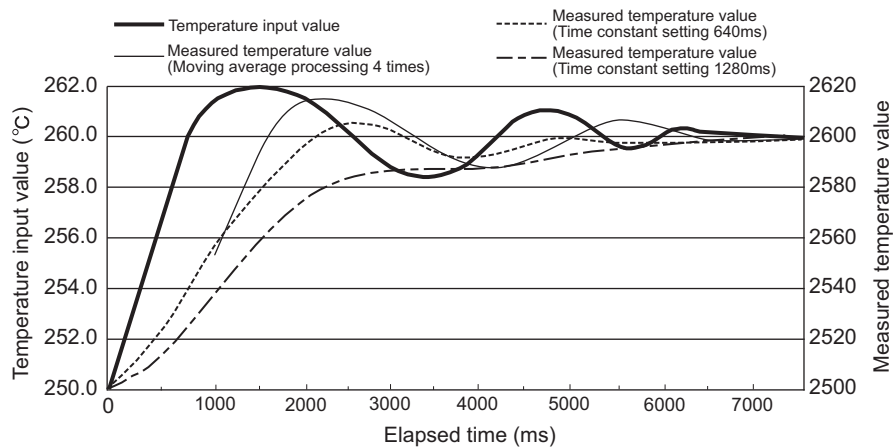

3.2.2 Conversion setting for disconnection detection function

(1) This function is to select a value to be stored in the CH□ Measured temperature value (Un\G11 to Un\G18) from "Up scale", "Down scale" or "Given value" when disconnection is detected.
The Conversion setting for disconnection detection (Un\G164 and Un\G165) can be set for each channel.

(2) This function is effective for only conversion-enabled channels.

(3) When "Up scale" (0H) or "Down scale" (1H) is selected, an up scale value or down scale value of the measurement range to be used is stored.

Table 3.6 Measured temperature value when disconnection is detected

Setting		Measurement range	Measured temperature value when disconnection is detected	
RTD type	Setting value *1		Up scale	Down scale
Pt100	0 _H	-200 to 850°C	902.5°C	-252.5°C
	1 _H	-20 to 120°C	127.0°C	-27.0°C
	4 _H	0 to 200°C	210.0°C	-10.0°C
JPt100	2 _H	-180 to 600°C	639.0°C	-219.0°C
	3 _H	-20 to 120°C	127.0°C	-27.0°C
	5 _H	0 to 200°C	210.0°C	-10.0°C
Ni100	8 _H	-60 to 180°C	192.0°C	-72.0°C

* 1 RTD type to be used and measurement range are set in the intelligent function module switch setting. (Refer to Section 4.5.)

(4) When "Given value" (2H) is selected, set a value in the CH□ Conversion setting value for disconnection detection (Un\G166 to Un\G173) in units of 0.1°C.

The value set in the buffer memory above is stored in the CH□ Measured temperature value (Un\G11 to Un\G18) when disconnection is detected.

(5) It takes 320ms (maximum) to detect a disconnection state.

- (6) It takes 640ms (maximum) to obtain normal measured temperature values after connection is restored.
Temperature conversion restarts 640ms after connection is restored. When averaging processing is set, it takes another 640ms and time required for averaging processing before normal measured temperature values are stored to the CH□ Measured temperature value (Un\G11 to Un\G18) after the restart of temperature conversion. During the time before normal measured temperature values are stored in the buffer memory, the measured temperature values remain the value specified in the The Conversion setting for disconnection detection (Un\G164 and Un\G165), such as "Down scale".
- (7) For operation of the warning output function when disconnection is detected or recovered, refer to Section 3.2.3.

3.2.3 Warning output function

(1) Process alarm

(a) Warning occurrence

When the detected measured temperature value is higher than or equal to the process alarm upper upper limit value, or lower than or equal to the process alarm lower lower limit value (when the value enters the warning output range), a warning occurs.

When a warning occurs, "1" is stored to the bit of the corresponding channel in the Warning output flag (Process alarm) (Un\G47), Warning output signal (XD) turns ON, and the "ALM" LED turns on.

(b) Warning clearance

After a warning occurs, when the temperature value is lower than the process alarm upper lower limit value or higher than the process alarm lower upper limit value (when the value returns to within the setting range), the warning is cleared. When the warning is cleared, "0" is stored to the bit of the corresponding channel in the Warning output flag (Process alarm) (Un\G47).

Warning output signal (XD) turns OFF only when the values for all channels return to within the setting range.

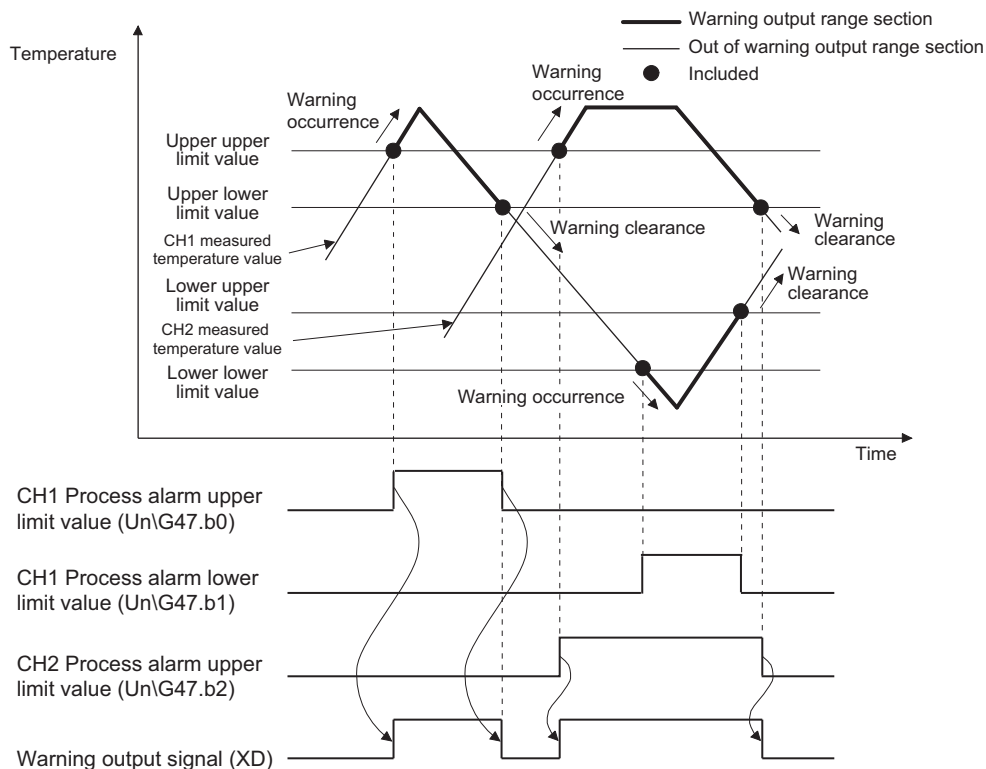

- (c) Settable temperature range and default value vary according to the RTD type to be used and measurement range.

Values are set in units of 0.1°C.

Table 3.7 Settable range and default value of process alarm

RTD type	Measurement range	Default value				Settable temperature range (Accuracy guarantee range) (in units of 0.1°C)
		Process alarm lower upper limit value (in units of 0.1°C)	Process alarm lower lower limit value (in units of 0.1°C)	Process alarm upper upper limit value (in units of 0.1°C)	Process alarm upper lower limit value (in units of 0.1°C)	
Pt100 (New JIS)	-200 to 850°C	-2000		8500		-2000 to 8500
	-20 to 120°C	-200		1200		-200 to 1200
	0 to 200°C	0		2000		0 to 2000
JPt100 (Old JIS)	-180 to 600°C	-1800		6000		-1800 to 6000
	-20 to 120°C	-200		1200		-200 to 1200
	0 to 200°C	0		2000		0 to 2000
Ni100	-60 to 180°C	-600		1800		-600 to 1800

- (d) When time average or count average is specified, process alarm processing is executed for each preset time or count.
When other temperature conversion system (sampling processing, moving average or primary delay filter) is specified, process alarm processing is executed at every sampling period.
- (e) When disconnection state is detected, the measured temperature value is replaced with the setting in the Conversion setting for disconnection detection (Un\G164 and Un\G165), such as "Down scale". As a result, a warning may occur.

(2) Rate alarm

(a) Warning occurrence

When the measured temperature value is monitored at every rate alarm warning detection period and the changed portion from the preceding value is larger than or equal to the rate alarm upper limit value, or smaller than or equal to the rate alarm lower limit value, a warning occurs.

When a warning occurs, "1" is stored to the bit of the corresponding channel in the Warning output flag (Rate alarm) (Un\G48), Warning output signal (XD) turns ON, and the "ALM" LED turns on.

(b) Warning clearance

After a warning occurrence, when the changed portion of the measured temperature value is smaller than the rate alarm upper limit value or larger than the rate alarm lower limit value (when the value returns to within the setting range), the warning is cleared.

When the warning is cleared, "0" is stored to the bit of the corresponding channel in the Warning output flag (Rate alarm) (Un\G48).

Warning output signal (XD) turns OFF only when the values for all channels return to within the setting range.

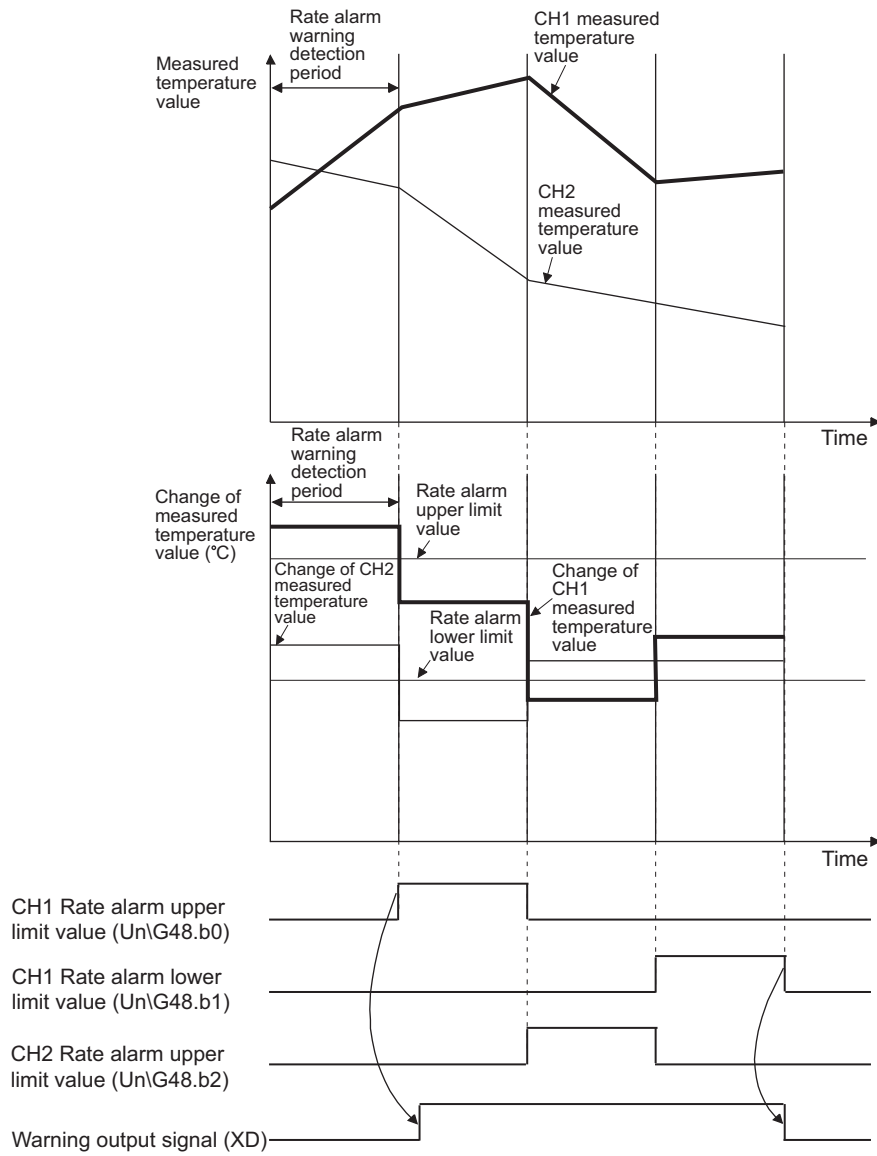

- (c) The rate alarm upper limit/lower limit values are set in units of 0.1°C for the measured temperature range.
 Setting range is -32768 to 32767 (-3276.8°C to 3276.7°C).
 The default value is set to "0".
- (d) The rate alarm warning detection period is set based on the number of conversion periods.
 Setting range is 1 to 6000 (times).
 Calculation method of the rate alarm warning detection period is below.
 (Rate alarm warning detection period)
 = (Setting value of the Rate alarm warning detection period) × (Conversion period) (320ms)

[Example 1: When setting the rate alarm warning detection period to 150 times with sampling processing]

$$\text{Rate alarm warning detection period} = 150 \text{ times} \times 320\text{ms} = 48000\text{ms} = 48\text{s}$$

[Example 2: When setting the rate alarm warning detection period to 150 times with averaging processing (count average: 10 times)]

$$\text{Rate alarm warning detection period} = 150 \text{ times} \times 10 \text{ times} \times 320\text{ms} = 480000\text{ms} = 480\text{s}$$

- (e) Rate alarm is effective to monitor a change of measured temperature values within a limited range.
 - 1) Setting example of the rate alarm upper/lower limit values for monitoring that a measured temperature value increases within the specified range

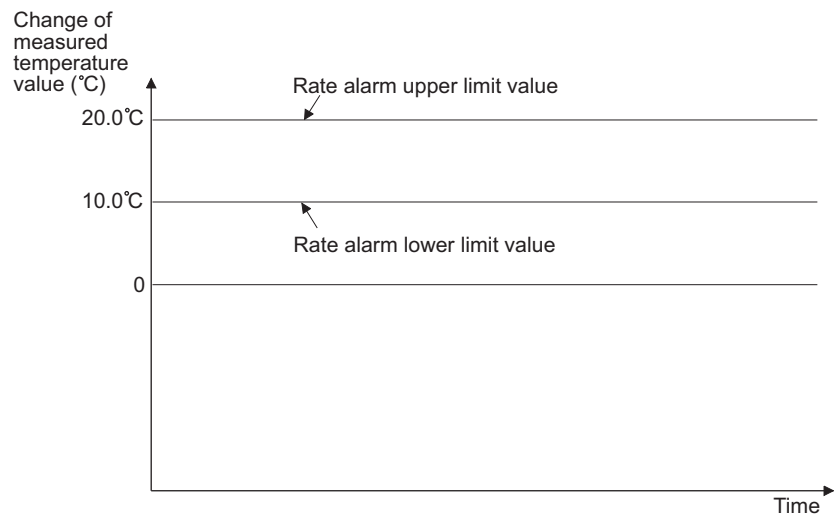

- 2) Setting example of the rate alarm upper/lower limit values for monitoring that a measured temperature value decreases within the specified range

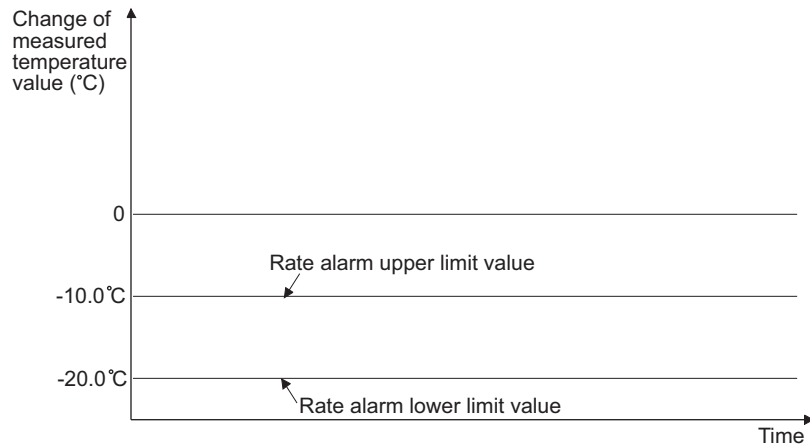

- 3) Setting example of the rate alarm upper/lower limit values for monitoring that a measured temperature value changes within the specified range

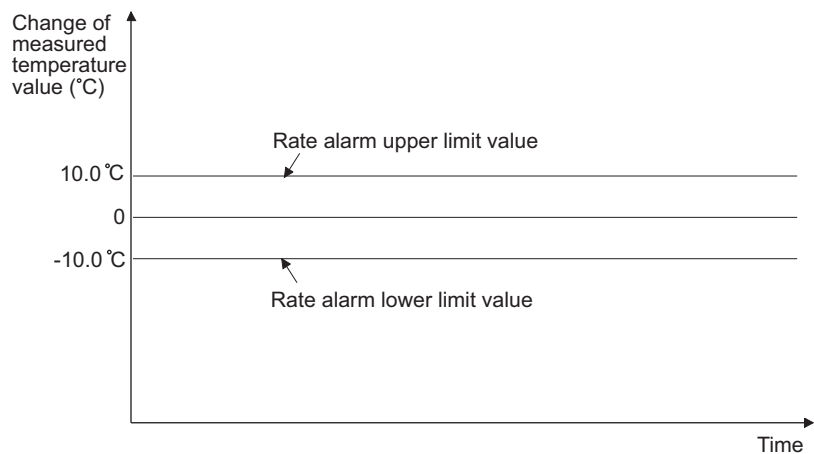

- (f) When disconnection state is detected, the measured temperature value is replaced with the setting in the Conversion setting for disconnection detection (Un\G164 and Un\G165), such as "Down scale". As a result, a warning may occur.
- (g) After connection is restored, preceding values required for rate alarm occurrence are cleared.
Therefore, a warning does not occur even though the changed portion of measured temperature values before and after temperature conversion exceeds the setting range when temperature conversion is restarted.

3.3 I/O Signals for Communicating with Programmable Controller CPU

This section describes the I/O signal assignment and the function of each signal.

3.3.1 I/O signal list

The following table lists the I/O signals of the Q68RD3-G.

The I/O numbers (X/Y) described in this chapter and later indicate the case where the start I/O number of the Q68RD3-G is set to "0".

Table 3.8 I/O signal list

Input signal (Signal direction: Programmable controller CPU ← Q68RD3-G)		Output signal (Signal direction: Programmable controller CPU → Q68RD3-G)	
Device No.	Signal name	Device No.	Signal name
X0	Module ready	Y0	Reserved *1
X1	Reserved *1	Y1	
X2		Y2	
X3		Y3	
X4		Y4	
X5		Y5	
X6		Y6	
X7		Y7	
X8		Y8	
X9		Operating condition setting completion flag	Y9
XA	Offset/gain setting mode status flag	YA	User range write request
XB	Channel change completion flag	YB	Channel change request
XC	Disconnection detection signal	YC	Reserved *1
XD	Warning output signal	YD	
XE	Conversion completion flag	YE	
XF	Error flag	YF	Error clear request

☒ POINT

The reserved signals marked *1 are used by the system and are not available for the user. If they are turned ON/OFF in a sequence program, the functions of those signals in the Q68RD3-G cannot be guaranteed.

3.3.2 I/O signal details

This section describes details of the Q68RD3-G I/O signals.

(1) Module ready (X0)

- (a) If the module is in the normal mode when the programmable controller is powered ON or the reset operation of the CPU module is performed, this signal turns ON to start conversion processing as soon as the module is ready.
- (b) When this signal is OFF in the normal mode, conversion processing is not performed. If the module is in the offset/gain setting mode, conversion processing is performed even if this signal is OFF.
- (c) In any of the following cases, this signal turns OFF.
 - The module is in the offset/gain setting mode.
 - A watchdog timer error occurs in the Q68RD3-G. *1

* 1 A watchdog timer error occurs when program operation does not complete within the intended time due to errors such as a hardware failure of the Q68RD3-G. The "RUN" LED of the Q68RD3-G turns off when a watchdog timer error occurs.

(2) Operation condition setting completion flag (X9)

- (a) When the following settings are changed, this signal is used as an interlock condition to turn ON/OFF Operation condition setting request (Y9).
 - Conversion enable/disable setting (Un\G0)
 - CH□ Time/Count/Moving average/Time constant setting (Un\G1 to Un\G8)
 - Averaging processing selection (Un\G24, Un\G25)
 - Warning output enable/disable setting (Un\G46)
 - Scaling valid/invalid setting (Un\G58)
 - CH□ Scaling range upper/lower limit values (Un\G62 to Un\G77)
 - CH□ Scaling width upper/lower limit values (Un\G78 to Un\G93)
 - CH□ Process alarm upper/lower limit values (Un\G94 to Un\G125)
 - CH□ Rate alarm warning detection period (Un\126 to Un\G133)
 - CH□ Rate alarm upper/lower limit values (Un\G134 to Un\G149)
 - Conversion setting for disconnection detection (Un\G164, Un\G165)
 - CH□ Conversion setting value for disconnection detection (Un\G166 to Un\G173)
- (b) When this signal is OFF, conversion processing is not performed.

(c) In the following case, this signal turns OFF.

- Operating condition setting request (Y9) is ON.

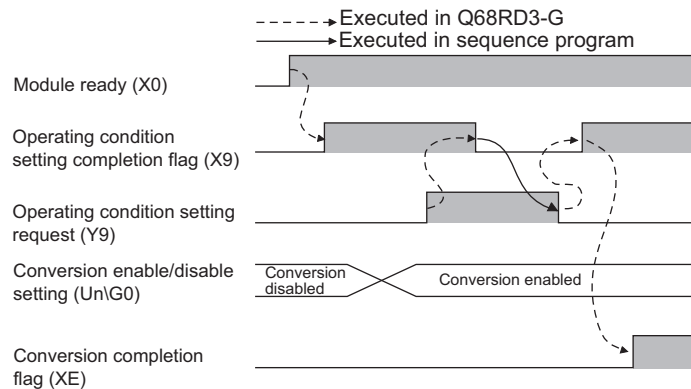

(3) Offset/gain setting mode status flag (XA)

(a) In offset/gain setting mode

- 1) This signal is used as an interlock condition to turn ON/OFF User range write request (YA) when values adjusted by offset/gain setting are written.
- 2) For offset/gain setting, refer to Section 4.6.

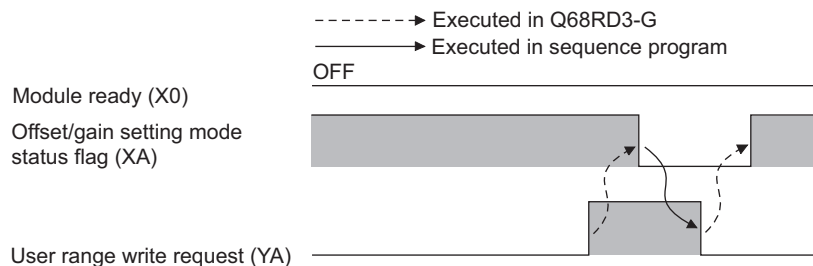

(b) In normal mode

- 1) This signal is used as an interlock condition to turn ON/OFF User range write request (YA) when the user range is restored.
- 2) For the user range restore function, refer to CHAPTER 7.

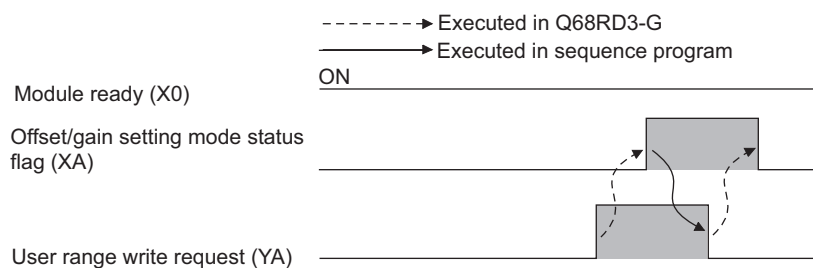

(4) Channel change completion flag (XB)

- (a) This signal is used as an interlock condition to turn ON/OFF Channel change request (YB) when changing the channel targeted for offset/gain setting.
- (b) For offset/gain setting, refer to Section 4.6.

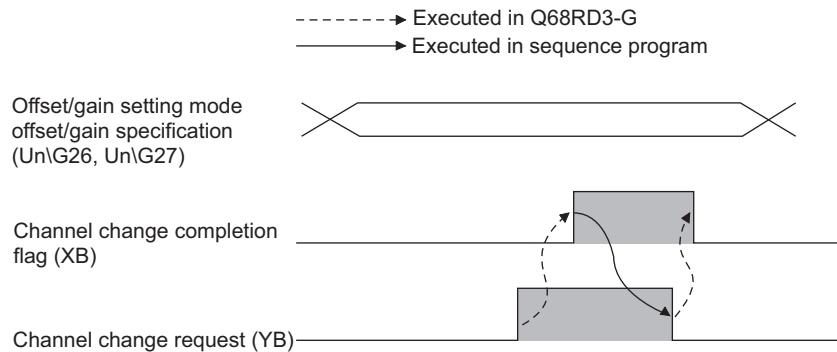
**(5) Disconnection detection signal (XC)**

- (a) This signal turns ON when any input signal line in the input circuit of the conversion-enabled channel is disconnected. To identify the disconnected channel, check Disconnection detection flag (Un\G49). When this signal turns ON, conversion update for the conversion-enabled channels stops.
- (b) Measured temperature value when this signal turns ON can be selected from "Up scale", "Down scale" or "Given value". (Refer to Section 3.2.2.)
- (c) This signal turns OFF after eliminating the cause of disconnection and turning ON Error clear request (YF).
- (d) When connection is restored, the measured temperature value update is restarted regardless of the reset of this signal.

(6) Warning output signal (XD)

- (a) This signal turns ON when a process alarm or rate alarm is detected.
- 1) Process alarm
 - This signal turns ON when the process alarm is enabled and a measured temperature value exceeds the preset range of the Process alarm upper/lower limit values (Un\G94 to Un\G125) in any of conversion-enabled channels.
 - This signal automatically turns OFF when the measured temperature value returns to within the setting range for all conversion-enabled channels. The "ALM" LED also turns off.

2) Rate alarm

- This signal turns ON when the rate alarm is enabled and the change of measured temperature value exceeds the preset range of the Rate alarm upper/lower limit values (Un\G134 to Un\G149) in any of conversion-enabled channels.
- This signal automatically turns OFF when the change of measured temperature value returns to within the setting range for all conversion-enabled channels. The "ALM" LED also turns off.

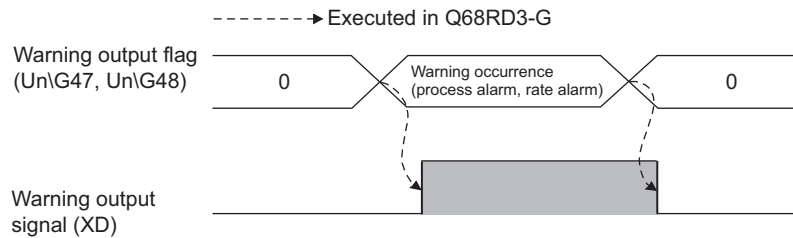

(7) Conversion completion flag (XE)

- This flag turns ON when measured temperature values of all conversion-enabled channels are stored into the buffer memory after the programmable controller is powered ON or the reset operation of the CPU module is performed.
- When averaging processing is specified, this signal also turns ON when the converted measured temperature values are stored into the buffer memory after completion of averaging processing.
- Status of this flag depends on the ON/OFF status of Operating condition setting completion flag (X9).
 - When Operating condition setting completion flag (X9) turns ON (stop → conversion)
 - Temperature conversion for conversion-enabled channels is started.
 - After the measured temperature value is stored into the buffer memory, the bit of corresponding channel in the Conversion completion flag (Un\G10) turns ON (changes to "1").
 - After the measured temperature values of all conversion-enabled channels are stored into the buffer memory, this flag turns ON.
 - When Operating condition setting completion flag (X9) turns OFF (conversion → stop)
 - The bits of all channels in the Conversion completion flag (Un\G10) are turned OFF (changes to "0").
 - This flag turns OFF.

Note that even though conversion has been stopped, the data immediately before the stop are held in the Measured temperature values stored in the buffer memory.
- Use this signal or the Conversion completion flag (Un\G10) as an interlock to read out the measured temperature value.
- This flag does not turn ON when all channels are set to conversion-disabled.

(8) Error flag (XF)

- (a) This signal turns ON when a write error occurs.
- (b) To clear the error code, turn ON Error clear request (YF).

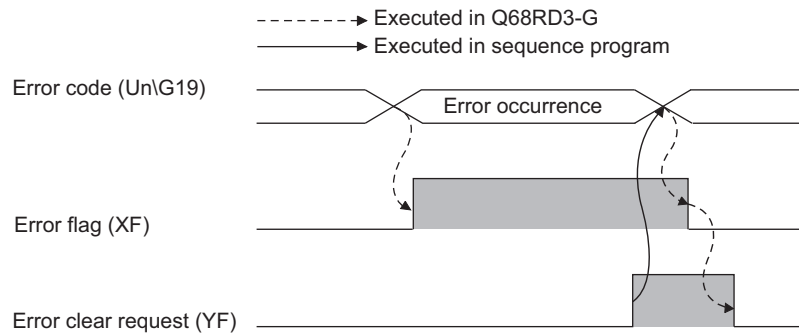
**(9) Operating condition setting request (Y9)**

- (a) This signal is turned ON when enabling the following settings.
- Conversion enable/disable setting (Un\G0)
 - CH□ Time/Count/Moving average/Time constant setting (Un\G1 to Un\G8)
 - Averaging processing selection (Un\G24, Un\G25)
 - Warning output enable/disable setting (Un\G46)
 - Scaling valid/invalid setting (Un\G58)
 - CH□ Scaling range upper/lower limit values (Un\G62 to Un\G77)
 - CH□ Scaling width upper/lower limit values (Un\G78 to Un\G93)
 - CH□ Process alarm upper/lower limit values (Un\G94 to Un\G125)
 - CH□ Rate alarm warning detection period (Un\G126 to Un\G133)
 - CH□ Rate alarm upper/lower limit values (Un\G134 to Un\G149)
 - Conversion setting for disconnection detection (Un\G164, Un\G165)
 - CH□ Conversion setting value for disconnection detection (Un\G166 to Un\G173)
- (b) When this signal is turned ON, Disconnection detection signal (XC) and Warning output signal (XD) turn OFF.
- (c) For the ON/OFF timing, refer to the description for Operating condition setting completion flag (X9).

(10) User range write request (YA)

- (a) In offset/gain setting mode
 - 1) This signal is turned ON when the offset/gain setting adjusted values are written to the Flash memory.
 - 2) For the ON/OFF timing, refer to the description for Offset/gain setting mode status flag (XA).
For offset/gain setting, refer to Section 4.6.
- (b) In normal mode
 - 1) This signal is turned ON when the user range is restored.
 - 2) For the ON/OFF timing, refer to the description for Offset/gain setting mode status flag (XA).
For the user range restore function, refer to CHAPTER 7.

(11) Channel change request (YB)

- (a) This signal is turned ON when changing the offset/gain setting target channel.
- (b) For the ON/OFF timing, refer to the description for Channel change completion flag (XB).
For offset/gain setting, refer to Section 4.6.

(12) Error clear request (YF)

- (a) This signal is turned ON when clearing Error flag (XF) and Disconnection detection signal (XC).
However, a setting value error of the intelligent function module switch setting cannot be cleared.
Correct the setting value.
- (b) For the ON/OFF timing, refer to the descriptions for Disconnection detection signal (XC) and Error flag (XF).

3.4 Buffer Memory

3.4.1 Buffer memory assignment

This section describes the assignment of the Q68RD3-G buffer memory.

POINT

Do not write data to the system area or the area where writing data from a sequence program is disabled.

Doing so may cause a malfunction of the module.

Table 3.9 Buffer memory assignment (1/6)

Address		Description	Default value	Read/Write ^{*1}	Reference section
Hex.	Dec.				
00H	0	Conversion enable/disable setting	00FFH	R/W ^{*2}	Section 3.4.2
01H	1	CH1 Time/Count/Moving average/Time constant setting	0	R/W ^{*2}	Section 3.4.3
02H	2	CH2 Time/Count/Moving average/Time constant setting	0	R/W ^{*2}	
03H	3	CH3 Time/Count/Moving average/Time constant setting	0	R/W ^{*2}	
04H	4	CH4 Time/Count/Moving average/Time constant setting	0	R/W ^{*2}	
05H	5	CH5 Time/Count/Moving average/Time constant setting	0	R/W ^{*2}	
06H	6	CH6 Time/Count/Moving average/Time constant setting	0	R/W ^{*2}	
07H	7	CH7 Time/Count/Moving average/Time constant setting	0	R/W ^{*2}	
08H	8	CH8 Time/Count/Moving average/Time constant setting	0	R/W ^{*2}	
09H	9	System area	—	—	—
0AH	10	Conversion completion flag	0	R	Section 3.4.4
0BH	11	CH1 Measured temperature value	0	R	Section 3.4.5
0CH	12	CH2 Measured temperature value	0	R	
0DH	13	CH3 Measured temperature value	0	R	
0EH	14	CH4 Measured temperature value	0	R	
0FH	15	CH5 Measured temperature value	0	R	
10H	16	CH6 Measured temperature value	0	R	
11H	17	CH7 Measured temperature value	0	R	
12H	18	CH8 Measured temperature value	0	R	
13H	19	Error code	0	R	Section 3.4.6
14H	20	Setting range (Input type CH1-4)	0	R	Section 3.4.7
15H	21	Setting range (Input type CH5-8)	0	R	Section 3.4.8
16H	22	Setting range (Offset/gain setting CH1-CH8)	0	R	Section 3.4.8
17H	23	System area	—	—	—
18H	24	Averaging processing selection (CH1-CH4)	0	R/W ^{*2}	Section 3.4.9
19H	25	Averaging processing selection (CH5-CH8)	0	R/W ^{*2}	
1AH	26	Offset/gain setting mode (Offset specification)	0	R/W ^{*2}	Section 3.4.10
1BH	27	Offset/gain setting mode (Gain specification)	0	R/W ^{*2}	
1CH	28	CH1 Offset temperature setting value	0	R/W ^{*2}	Section 3.4.11
1DH	29	CH1 Gain temperature setting value	0	R/W ^{*2}	
1EH	30	CH2 Offset temperature setting value	0	R/W ^{*2}	
1FH	31	CH2 Gain temperature setting value	0	R/W ^{*2}	
20H	32	CH3 Offset temperature setting value	0	R/W ^{*2}	
21H	33	CH3 Gain temperature setting value	0	R/W ^{*2}	
22H	34	CH4 Offset temperature setting value	0	R/W ^{*2}	
23H	35	CH4 Gain temperature setting value	0	R/W ^{*2}	

Table 3.9 Buffer memory assignment (2/6)

Address		Description	Default value	Read/Write ^{*1}	Reference section
Hex.	Dec.				
24H	36	CH5 Offset temperature setting value	0	R/W ^{*2}	Section 3.4.11
25H	37	CH5 Gain temperature setting value	0	R/W ^{*2}	
26H	38	CH6 Offset temperature setting value	0	R/W ^{*2}	
27H	39	CH6 Gain temperature setting value	0	R/W ^{*2}	
28H	40	CH7 Offset temperature setting value	0	R/W ^{*2}	
29H	41	CH7 Gain temperature setting value	0	R/W ^{*2}	
2AH	42	CH8 Offset temperature setting value	0	R/W ^{*2}	
2BH	43	CH8 Gain temperature setting value	0	R/W ^{*2}	
2CH	44	System area	—	—	—
2DH	45				
2EH	46	Warning output enable/disable setting	FFFFH	R/W ^{*2}	Section 3.4.12
2FH	47	Warning output flag (Process alarm)	0	R	Section 3.4.13
30H	48	Warning output flag (Rate alarm)	0	R	Section 3.4.14
31H	49	Disconnection detection flag	0	R	
32H	50	CH1 Scaling value	0	R	Section 3.4.15
33H	51	CH2 Scaling value	0	R	
34H	52	CH3 Scaling value	0	R	
35H	53	CH4 Scaling value	0	R	
36H	54	CH5 Scaling value	0	R	
37H	55	CH6 Scaling value	0	R	
38H	56	CH7 Scaling value	0	R	
39H	57	CH8 Scaling value	0	R	
3AH	58	Scaling valid/invalid setting	00FFH	R/W ^{*2}	Section 3.4.16
3BH	59	System area	—	—	—
to	to				
3DH	61				
3EH	62	CH1 Scaling range lower limit value	0	R/W ^{*2}	Section 3.4.17
3FH	63	CH1 Scaling range upper limit value	0	R/W ^{*2}	
40H	64	CH2 Scaling range lower limit value	0	R/W ^{*2}	
41H	65	CH2 Scaling range upper limit value	0	R/W ^{*2}	
42H	66	CH3 Scaling range lower limit value	0	R/W ^{*2}	
43H	67	CH3 Scaling range upper limit value	0	R/W ^{*2}	
44H	68	CH4 Scaling range lower limit value	0	R/W ^{*2}	
45H	69	CH4 Scaling range upper limit value	0	R/W ^{*2}	
46H	70	CH5 Scaling range lower limit value	0	R/W ^{*2}	
47H	71	CH5 Scaling range upper limit value	0	R/W ^{*2}	
48H	72	CH6 Scaling range lower limit value	0	R/W ^{*2}	
49H	73	CH6 Scaling range upper limit value	0	R/W ^{*2}	
4AH	74	CH7 Scaling range lower limit value	0	R/W ^{*2}	
4BH	75	CH7 Scaling range upper limit value	0	R/W ^{*2}	
4CH	76	CH8 Scaling range lower limit value	0	R/W ^{*2}	
4DH	77	CH8 Scaling range upper limit value	0	R/W ^{*2}	
4EH	78	CH1 Scaling width lower limit value	0	R/W ^{*2}	Section 3.4.18
4FH	79	CH1 Scaling width upper limit value	0	R/W ^{*2}	
50H	80	CH2 Scaling width lower limit value	0	R/W ^{*2}	
51H	81	CH2 Scaling width upper limit value	0	R/W ^{*2}	
52H	82	CH3 Scaling width lower limit value	0	R/W ^{*2}	
53H	83	CH3 Scaling width upper limit value	0	R/W ^{*2}	

1 OVERVIEW
2 SYSTEM CONFIGURATION
3 SPECIFICATIONS
4 PROCEDURES AND SETTINGS BEFORE SYSTEM OPERATION
5 UTILITY PACKAGE (GX CONFIGURATOR-TI)
6 PROGRAMMING
7 ONLINE MODULE CHANGE
8 TROUBLESHOOTING

Table 3.9 Buffer memory assignment (3/6)

Address		Description	Default value	Read/Write ^{*1}	Reference section
Hex.	Dec.				
54H	84	CH4 Scaling width lower limit value	0	R/W ^{*2}	Section 3.4.18
55H	85	CH4 Scaling width upper limit value	0	R/W ^{*2}	
56H	86	CH5 Scaling width lower limit value	0	R/W ^{*2}	
57H	87	CH5 Scaling width upper limit value	0	R/W ^{*2}	
58H	88	CH6 Scaling width lower limit value	0	R/W ^{*2}	
59H	89	CH6 Scaling width upper limit value	0	R/W ^{*2}	
5AH	90	CH7 Scaling width lower limit value	0	R/W ^{*2}	
5BH	91	CH7 Scaling width upper limit value	0	R/W ^{*2}	
5CH	92	CH8 Scaling width lower limit value	0	R/W ^{*2}	
5DH	93	CH8 Scaling width upper limit value	0	R/W ^{*2}	
5EH	94	CH1 Process alarm lower lower limit value	-2000	R/W ^{*2}	Section 3.4.10
5FH	95	CH1 Process alarm lower upper limit value	-2000	R/W ^{*2}	
60H	96	CH1 Process alarm upper lower limit value	8500	R/W ^{*2}	
61H	97	CH1 Process alarm upper upper limit value	8500	R/W ^{*2}	
62H	98	CH2 Process alarm lower lower limit value	-2000	R/W ^{*2}	
63H	99	CH2 Process alarm lower upper limit value	-2000	R/W ^{*2}	
64H	100	CH2 Process alarm upper lower limit value	8500	R/W ^{*2}	
65H	101	CH2 Process alarm upper upper limit value	8500	R/W ^{*2}	
66H	102	CH3 Process alarm lower lower limit value	-2000	R/W ^{*2}	
67H	103	CH3 Process alarm lower upper limit value	-2000	R/W ^{*2}	
68H	104	CH3 Process alarm upper lower limit value	8500	R/W ^{*2}	
69H	105	CH3 Process alarm upper upper limit value	8500	R/W ^{*2}	
6AH	106	CH4 Process alarm lower lower limit value	-2000	R/W ^{*2}	
6BH	107	CH4 Process alarm lower upper limit value	-2000	R/W ^{*2}	
6CH	108	CH4 Process alarm upper lower limit value	8500	R/W ^{*2}	
6DH	109	CH4 Process alarm upper upper limit value	8500	R/W ^{*2}	
6EH	110	CH5 Process alarm lower lower limit value	-2000	R/W ^{*2}	
6FH	111	CH5 Process alarm lower upper limit value	-2000	R/W ^{*2}	
70H	112	CH5 Process alarm upper lower limit value	8500	R/W ^{*2}	
71H	113	CH5 Process alarm upper upper limit value	8500	R/W ^{*2}	
72H	114	CH6 Process alarm lower lower limit value	-2000	R/W ^{*2}	
73H	115	CH6 Process alarm lower upper limit value	-2000	R/W ^{*2}	
74H	116	CH6 Process alarm upper lower limit value	8500	R/W ^{*2}	
75H	117	CH6 Process alarm upper upper limit value	8500	R/W ^{*2}	
76H	118	CH7 Process alarm lower lower limit value	-2000	R/W ^{*2}	
77H	119	CH7 Process alarm lower upper limit value	-2000	R/W ^{*2}	
78H	120	CH7 Process alarm upper lower limit value	8500	R/W ^{*2}	
79H	121	CH7 Process alarm upper upper limit value	8500	R/W ^{*2}	
7AH	122	CH8 Process alarm lower lower limit value	-2000	R/W ^{*2}	
7BH	123	CH8 Process alarm lower upper limit value	-2000	R/W ^{*2}	
7CH	124	CH8 Process alarm upper lower limit value	8500	R/W ^{*2}	
7DH	125	CH8 Process alarm upper upper limit value	8500	R/W ^{*2}	
7EH	126	CH1 Rate alarm warning detection period	0	R/W ^{*2}	Section 3.4.20
7FH	127	CH2 Rate alarm warning detection period	0	R/W ^{*2}	
80H	128	CH3 Rate alarm warning detection period	0	R/W ^{*2}	
81H	129	CH4 Rate alarm warning detection period	0	R/W ^{*2}	
82H	130	CH5 Rate alarm warning detection period	0	R/W ^{*2}	

3 SPECIFICATIONS

Table 3.9 Buffer memory assignment (4/6)

Address		Description	Default value	Read/Write ^{*1}	Reference section			
Hex.	Dec.							
83H	131	CH6 Rate alarm warning detection period	0	R/W ^{*2}	Section 3.4.20			
84H	132	CH7 Rate alarm warning detection period	0	R/W ^{*2}				
85H	133	CH8 Rate alarm warning detection period	0	R/W ^{*2}				
86H	134	CH1 Rate alarm upper limit value	0	R/W ^{*2}	Section 3.4.21			
87H	135	CH1 Rate alarm lower limit value	0	R/W ^{*2}				
88H	136	CH2 Rate alarm upper limit value	0	R/W ^{*2}				
89H	137	CH2 Rate alarm lower limit value	0	R/W ^{*2}				
8AH	138	CH3 Rate alarm upper limit value	0	R/W ^{*2}				
8BH	139	CH3 Rate alarm lower limit value	0	R/W ^{*2}				
8CH	140	CH4 Rate alarm upper limit value	0	R/W ^{*2}				
8DH	141	CH4 Rate alarm lower limit value	0	R/W ^{*2}				
8EH	142	CH5 Rate alarm upper limit value	0	R/W ^{*2}				
8FH	143	CH5 Rate alarm lower limit value	0	R/W ^{*2}				
90H	144	CH6 Rate alarm upper limit value	0	R/W ^{*2}				
91H	145	CH6 Rate alarm lower limit value	0	R/W ^{*2}				
92H	146	CH7 Rate alarm upper limit value	0	R/W ^{*2}				
93H	147	CH7 Rate alarm lower limit value	0	R/W ^{*2}				
94H	148	CH8 Rate alarm upper limit value	0	R/W ^{*2}				
95H	149	CH8 Rate alarm lower limit value	0	R/W ^{*2}				
96H	150	System area	—	—	—			
to	to							
9DH	157	Mode switching setting	0	R/W ^{*2}	Section 3.4.22			
9EH	158							
9FH	159							
A0H	160	System area	—	—	—			
to	to							
A3H	163	Conversion setting for disconnection detection1 (CH1-CH4)	1111H	R/W ^{*2}	Section 3.4.23			
A4H	164							
A5H	165	Conversion setting for disconnection detection2 (CH5-CH8)	1111H	R/W ^{*2}	Section 3.4.24			
A6H	166	CH1 Conversion setting value for disconnection detection	0	R/W ^{*2}				
A7H	167	CH2 Conversion setting value for disconnection detection	0	R/W ^{*2}				
A8H	168	CH3 Conversion setting value for disconnection detection	0	R/W ^{*2}				
A9H	169	CH4 Conversion setting value for disconnection detection	0	R/W ^{*2}				
AAH	170	CH5 Conversion setting value for disconnection detection	0	R/W ^{*2}				
ABH	171	CH6 Conversion setting value for disconnection detection	0	R/W ^{*2}				
ACH	172	CH7 Conversion setting value for disconnection detection	0	R/W ^{*2}				
ADH	173	CH8 Conversion setting value for disconnection detection	0	R/W ^{*2}				
AEH	174	System area	—	—	—			
to	to							
BDH	189	CH1 Factory default offset value ^{*3}	0	R/W ^{*2}	Section 3.4.25			
BEH	190							
BFH	191					CH1 Factory default gain value ^{*3}	0	R/W ^{*2}
C0H	192					CH1 User range settings offset value ^{*3}	0	R/W ^{*2}
C1H	193					CH1 User range settings gain value ^{*3}	0	R/W ^{*2}
C2H	194					CH1 User range settings resistance offset value (L) ^{*3}	0	R/W ^{*2}
C3H	195	CH1 User range settings resistance offset value (H) ^{*3}						

1 OVERVIEW
2 SYSTEM CONFIGURATION
3 SPECIFICATIONS
4 PROCEDURES AND SETTINGS BEFORE SYSTEM OPERATION
5 UTILITY PACKAGE (GX CONFIGURATOR-TI)
6 PROGRAMMING
7 ONLINE MODULE CHANGE
8 TROUBLESHOOTING

Table 3.9 Buffer memory assignment (5/6)

Address		Description	Default value	Read/Write ^{*1}	Reference section
Hex.	Dec.				
C4H	196	CH1 User range settings resistance gain value (L) ^{*3}	0	RW ^{*2}	Section 3.4.25
C5H	197	CH1 User range settings resistance gain value (H) ^{*3}			
C6H	198	CH2 Factory default offset value ^{*3}	0	RW ^{*2}	
C7H	199	CH2 Factory default gain value ^{*3}	0	RW ^{*2}	
C8H	200	CH2 User range settings offset value ^{*3}	0	RW ^{*2}	
C9H	201	CH2 User range settings gain value ^{*3}	0	RW ^{*2}	
CAH	202	CH2 User range settings resistance offset value (L) ^{*3}	0	RW ^{*2}	
CBH	203	CH2 User range settings resistance offset value (H) ^{*3}			
CCH	204	CH2 User range settings resistance gain value (L) ^{*3}	0	RW ^{*2}	
CDH	205	CH2 User range settings resistance gain value (H) ^{*3}			
CEH	206	CH3 Factory default offset value ^{*3}	0	RW ^{*2}	
CFH	207	CH3 Factory default gain value ^{*3}	0	RW ^{*2}	
D0H	208	CH3 User range settings offset value ^{*3}	0	RW ^{*2}	
D1H	209	CH3 User range settings gain value ^{*3}	0	RW ^{*2}	
D2H	210	CH3 User range settings resistance offset value (L) ^{*3}	0	RW ^{*2}	
D3H	211	CH3 User range settings resistance offset value (H) ^{*3}			
D4H	212	CH3 User range settings resistance gain value (L) ^{*3}	0	RW ^{*2}	
D5H	213	CH3 User range settings resistance gain value (H) ^{*3}			
D6H	214	CH4 Factory default offset value ^{*3}	0	RW ^{*2}	
D7H	215	CH4 Factory default gain value ^{*3}	0	RW ^{*2}	
D8H	216	CH4 User range settings offset value ^{*3}	0	RW ^{*2}	
D9H	217	CH4 User range settings gain value ^{*3}	0	RW ^{*2}	
DAH	218	CH4 User range settings resistance offset value (L) ^{*3}	0	RW ^{*2}	
DBH	219	CH4 User range settings resistance offset value (H) ^{*3}			
DCH	220	CH4 User range settings resistance gain value (L) ^{*3}	0	RW ^{*2}	
DDH	221	CH4 User range settings resistance gain value (H) ^{*3}			
DEH	222	CH5 Factory default offset value ^{*3}	0	RW ^{*2}	
DFH	223	CH5 Factory default gain value ^{*3}	0	RW ^{*2}	
E0H	224	CH5 User range settings offset value ^{*3}	0	RW ^{*2}	
E1H	225	CH5 User range settings gain value ^{*3}	0	RW ^{*2}	
E2H	226	CH5 User range settings resistance offset value (L) ^{*3}	0	RW ^{*2}	
E3H	227	CH5 User range settings resistance offset value (H) ^{*3}			
E4H	228	CH5 User range settings resistance gain value (L) ^{*3}	0	RW ^{*2}	
E5H	229	CH5 User range settings resistance gain value (H) ^{*3}			
E6H	230	CH6 Factory default offset value ^{*3}	0	RW ^{*2}	
E7H	231	CH6 Factory default gain value ^{*3}	0	RW ^{*2}	
E8H	232	CH6 User range settings offset value ^{*3}	0	RW ^{*2}	
E9H	233	CH6 User range settings gain value ^{*3}	0	RW ^{*2}	
EAH	234	CH6 User range settings resistance offset value (L) ^{*3}	0	RW ^{*2}	
EBH	235	CH6 User range settings resistance offset value (H) ^{*3}			
ECH	236	CH6 User range settings resistance gain value (L) ^{*3}	0	RW ^{*2}	
EDH	237	CH6 User range settings resistance gain value (H) ^{*3}			
EEH	238	CH7 Factory default offset value ^{*3}	0	RW ^{*2}	
EFH	239	CH7 Factory default gain value ^{*3}	0	RW ^{*2}	
F0H	240	CH7 User range settings offset value ^{*3}	0	RW ^{*2}	
F1H	241	CH7 User range settings gain value ^{*3}	0	RW ^{*2}	

Table 3.9 Buffer memory assignment (6/6)

Address		Description	Default value	Read/Write ^{*1}	Reference section
Hex.	Dec.				
F2H	242	CH7 User range settings resistance offset value (L) ^{*3}	0	R/W ^{*2}	Section 3.4.25
F3H	243	CH7 User range settings resistance offset value (H) ^{*3}			
F4H	244	CH7 User range settings resistance gain value (L) ^{*3}	0	R/W ^{*2}	
F5H	245	CH7 User range settings resistance gain value (H) ^{*3}			
F6H	246	CH8 Factory default offset value ^{*3}	0	R/W ^{*2}	
F7H	247	CH8 Factory default gain value ^{*3}	0	R/W ^{*2}	
F8H	248	CH8 User range settings offset value ^{*3}	0	R/W ^{*2}	
F9H	249	CH8 User range settings gain value ^{*3}	0	R/W ^{*2}	
FAH	250	CH8 User range settings resistance offset value (L) ^{*3}	0	R/W ^{*2}	
FBH	251	CH8 User range settings resistance offset value (H) ^{*3}			
FBH	251	CH8 User range settings resistance offset value (H) ^{*3}	0	R/W ^{*2}	
FCH	252	CH8 User range settings resistance gain value (L) ^{*3}			
FDH	253	CH8 User range settings resistance gain value (H) ^{*3}	0	R/W ^{*2}	

* 1 Indicates an availability of reading/writing data from/to a sequence program.

R : Read enabled W : Write enabled

* 2 Data must be written to buffer memory under the interlock conditions (buffer memory write conditions) of the following I/O signals.

- Operating condition setting



* 3 This area is related with the user range save/restore functions, which allows users to re-set the offset/gain values easily when performing online module change.

3.4.2 Conversion enable/disable setting (Un\G0)

- (1) Temperature conversion enable/disable status is set for each channel.
- (2) Setting "Disable" for unused channels can prevent unnecessary disconnection detection.
- (3) The default value is set to "Disable" for all channels.

b15	b14	b13	b12	b11	b10	b9	b8	b7	b6	b5	b4	b3	b2	b1	b0
0	0	0	0	0	0	0	0	CH8	CH7	CH6	CH5	CH4	CH3	CH2	CH1

Data for b8 to b15 are fixed to "0".

0: Enable
1: Disable

[Example]

b15	b14	b13	b12	b11	b10	b9	b8	b7	b6	b5	b4	b3	b2	b1	b0
0	0	0	0	0	0	0	0	1	1	1	1	1	1	0	0

Channel 1 and 2 are enabled for conversion.

- (4) To activate the setting, turning ON/OFF Operating condition setting request (Y9) is required.

3.4.3 CH□ Time/Count/Moving average/Time constant setting (Un\G1 to Un\G8)

- (1) Time average, count average, moving average or time constant for primary delay filter is set for each channel that is specified for averaging processing.
- (2) The default value is set to "0000H".
- (3) To activate the setting, turning ON/OFF Operating condition setting request (Y9) is required.
- (4) The following table shows the settable range.

Table 3.10 Settable range

Processing method	Setting value
Time average	1280 to 5000 (ms) ^{*1}
Count average	4 to 500 (times)
Moving average	2 to 60 (times)
Primary delay filter	320 to 5000 (ms) ^{*1}

* 1 : Values can be set in units of 1ms; however, processing is performed in units of 320ms.

☒ POINT

When a value out of the above setting range is written, an error (error code: 20□, 30□, 31□ or 32□) occurs on the channel. Then, Error flag (XF) turns ON and conversion processing is performed with the setting before the error occurrence.

3.4.4 Conversion completion flag (Un\G10)

- (1) The bit of the corresponding channel in the Conversion completion flag turns ON (changes to "1") when conversion of conversion-enabled channels is completed.

When averaging processing is specified, the flag turns ON (changes to "1") after the first averaged value is stored into the CH□ Measured temperature value (Un\G11 to Un\G18).

Conversion completion flag (XE) turns ON when conversion of all conversion-enabled channels is completed.

- (2) When Operating condition setting request (Y9) is turned ON, the bit returns to the default value of OFF ("0") and it turns ON ("1") after conversion is completed.

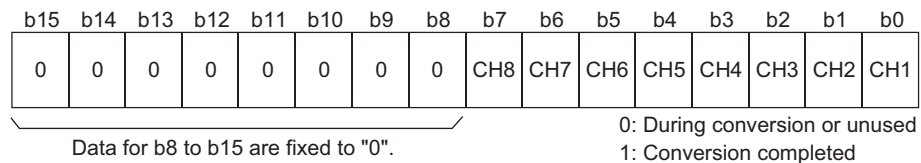

- (3) If disconnection is detected in the status where the bit of each channel in the Conversion completion flag (Un\G10) has already been ON ("1"), the bit remains ON ("1").
- (4) Use this area or the Conversion completion flag (XE) as an interlock to read out the measured temperature value.

3.4.5 CH□ Measured temperature value (Un\G11 to Un\G18)

- (1) Values input from RTD are converted into "temperature values" to detect temperature.
- (2) The measured temperature value rounded off to one decimal place is multiplied by 10 and the result is stored into the buffer memory in 16-bit signed binary. (Drop the second decimal place and later.)
- (3) The default value is set to "0" for all channels.

[Example 1]

When the measured temperature value is 123.025°C 1230 is stored.

b15	b14	b13	b12	b11	b10	b9	b8	b7	b6	b5	b4	b3	b2	b1	b0
0	0	0	0	0	1	0	0	1	1	0	0	1	1	1	0

[Example 2]

When the measured temperature value is -123.025°C -1230 is stored.

b15	b14	b13	b12	b11	b10	b9	b8	b7	b6	b5	b4	b3	b2	b1	b0
1	1	1	1	1	0	1	1	0	0	1	1	0	0	1	0

- (4) Use the Conversion completion flag (XE) or the Conversion completion flag (Un\G10) as an interlock to read out the measured temperature value.

3.4.6 Error code (Un\G19)

- (1) Error code that is detected by the Q68RD3-G is stored.
- (2) For details on error codes, refer to Section 8.1.

3.4.7 Setting range 1, 2 (Un\G20 and Un\G21)

- (1) This area is for checking the measurement range of the Q68RD3-G, which is set with Switch 1 and 2 in the intelligent function module switch setting.
Setting values of the measurement range are stored into the area indicated below for each channel.

	b15	to	b12	b11	to	b8	b7	to	b4	b3	to	b0
Un\G20 (Setting range 1 CH1-4)	CH4		CH3		CH2		CH1					
Un\G21 (Setting range 2 CH5-8)	CH8		CH7		CH6		CH5					

- (2) The following table shows the measurement range and setting value for each RTD.

Table 3.11 Measurement range and setting value

RTD	Measurement range	Setting value
Pt100	-200 to 850°C	0H
	-20 to 120°C	1H
	0 to 200°C	4H
JPt100	-180 to 600°C	2H
	-20 to 120°C	3H
	0 to 200°C	5H
Ni100	-60 to 180°C	8H

3.4.8 Setting range 3 (Offset/gain setting) (Un\G22)

- (1) This area is for checking the offset/gain setting of the Q68RD3-G, which is set with Switch 3 in the intelligent function module switch setting.
"0" is stored for factory default setting and "1" is stored for user range setting.

b15	b14	b13	b12	b11	b10	b9	b8	b7	b6	b5	b4	b3	b2	b1	b0
0	0	0	0	0	0	0	0	CH8	CH7	CH6	CH5	CH4	CH3	CH2	CH1

Data for b8 to b15 are fixed to "0".

0: Factory default setting
1: User range setting

3.4.9 Averaging processing selection (Un\G24 and Un\G25)

- (1) Sampling processing or averaging processing (time average, count average, moving average or primary delay filter) is selected for each channel.
- (2) The default value is set to "Sampling processing" for all channels.

	b15	to	b12 b11	to	b8 b7	to	b4 b3	to	b0
Un\G24 (Averaging processing selection CH1-4)	CH4		CH3		CH2		CH1		
Un\G25 (Averaging processing selection CH5-8)	CH8		CH7		CH6		CH5		

- (3) To activate the setting, turning ON/OFF Operating condition setting request (Y9) is required.
- (4) The following table shows the settable range.

Table 3.12 Processing method and setting value

Processing method	Setting value
Sampling processing	0H
Time average	1H
Count average	2H
Moving average	3H
Primary delay filter	4H

[Example]

To set count average, time average, primary delay filter, and sampling processing for Channel 1, 2, 3, and 4 respectively, set "0412H" in Un\G24.

☒ POINT

If a value out of the setting range is set, sampling processing is performed.

3.4.10 Offset/gain setting mode (Un\G26 and Un\G27)

- (1) A channel targeted for adjusting offset/gain setting values in the offset/gain setting mode is specified.
- (2) Specify a channel for offset setting in Un\G26, and a channel for gain setting in Un\G27.
- (3) Multiple channels can be set at the same time. Though, specify different channels for the offset and the gain settings; either one of Un\G26 or Un\G27 must be set to 0 for a channel. If both settings are set to the same channel, an error (error code 500) occurs.
- (4) For details on offset/gain setting, refer to Section 4.6.

	b15	b14	b13	b12	b11	b10	b9	b8	b7	b6	b5	b4	b3	b2	b1	b0
Un\G26 (Offset specification)	0	0	0	0	0	0	0	0	CH8	CH7	CH6	CH5	CH4	CH3	CH2	CH1
Un\G27 (Gain specification)	0	0	0	0	0	0	0	0	CH8	CH7	CH6	CH5	CH4	CH3	CH2	CH1

Data for b8 to b15 are fixed to "0".

1: Setting channel
0: Setting disabled

3.4.11 CH□ Offset/gain temperature setting values (Un\G28 to Un\G43)

- (1) Offset/gain temperature setting values are specified in 16-bit signed binary for each channel.
- (2) A value is set in units of 0.1°C.
- (3) When Channel change request (YB) is turned ON in the offset/gain setting mode, measured temperature value is compensated for the value written in this area.

☒ POINT

- (1) High accuracy is ensured for the Offset/gain temperature setting values when the minimum/maximum temperatures of the operating range are used to compensate errors.
- (2) Set the Offset/gain temperature setting values while reading measured temperature values.
- (3) Satisfy the following conditions when setting the Offset/gain temperature setting values. If the conditions are not satisfied, an error (error code: 41□) occurs.
 Condition 1: Within the input enabled range
 Condition 2:
 $(\text{Gain temperature setting value}) - (\text{Offset temperature setting value}) > 0.1[^\circ\text{C}]$
- (4) The offset/gain temperature setting values are stored into the Flash memory of the Q68RD3-G using the User range write request (YA), and the values are not erased at power-off.

3.4.12 Warning output enable/disable setting (Un\G46)

- (1) Enable/disable status of warning output for process alarm or rate alarm is set for each channel.
- (2) The default value is set to "Disable" for all channels.

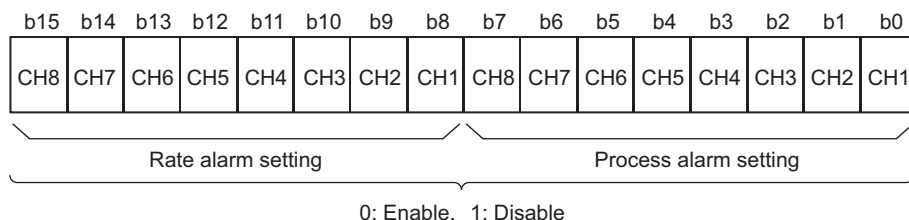

- (3) To activate the setting, turning ON/OFF Operating condition setting request (Y9) is required.

3.4.13 Warning output flag (Process alarm/Rate alarm) (Un\G47 and Un\G48)

- (1) When a measured temperature value is out of the setting range of the CH□ Process alarm upper/lower limit values (Un\G94 to Un\G125) or CH□ Rate alarm upper/lower limit values (Un\G134 to Un\G149), the bit of the corresponding channel turns ON (changes to "1").
- (2) For both process alarm and rate alarm, whether the warning is for the upper limit value or lower limit value can be checked for each channel.
- (3) When the measured temperature value or the change of measured temperature values returns to within the setting range, this flag will be automatically reset.
- (4) If a warning is detected on any of channels for which conversion and warning output of process alarm or rate alarm are enabled, Warning output signal (XD) also turns ON.
- (5) When Operating condition setting request (Y9) is turned ON, this flag will be cleared.

	b15	b14	b13	b12	b11	b10	b9	b8	b7	b6	b5	b4	b3	b2	b1	b0
Un\G47 (Process alarm)	CH8 lower limit value	CH8 upper limit value	CH7 lower limit value	CH7 upper limit value	CH6 lower limit value	CH6 upper limit value	CH5 lower limit value	CH5 upper limit value	CH4 lower limit value	CH4 upper limit value	CH3 lower limit value	CH3 upper limit value	CH2 lower limit value	CH2 upper limit value	CH1 lower limit value	CH1 upper limit value

0: Normal
1: Alarm ON

	b15	b14	b13	b12	b11	b10	b9	b8	b7	b6	b5	b4	b3	b2	b1	b0
Un\G48 (Rate alarm)	CH8 lower limit value	CH8 upper limit value	CH7 lower limit value	CH7 upper limit value	CH6 lower limit value	CH6 upper limit value	CH5 lower limit value	CH5 upper limit value	CH4 lower limit value	CH4 upper limit value	CH3 lower limit value	CH3 upper limit value	CH2 lower limit value	CH2 upper limit value	CH1 lower limit value	CH1 upper limit value

0: Normal
1: Alarm ON

3.4.14 Disconnection detection flag (Un\G49)

- (1) The flag of the corresponding channel turns ON (changes to "1") when the disconnection state of RTD is detected.
- (2) Disconnection detection is executed on conversion-enabled channels only.
- (3) Disconnection state is detectable for each channel.
- (4) If disconnection is detected on any of conversion-enabled channels, Disconnection detection signal (XC) also turns ON.
For a channel where disconnection is detected, a value based on the Conversion setting for disconnection detection (Un\G164 and Un\G165) is stored in the CH□ Measured temperature value (Un\G11 to Un\G18). Conversion for the channels not disconnected is continued.

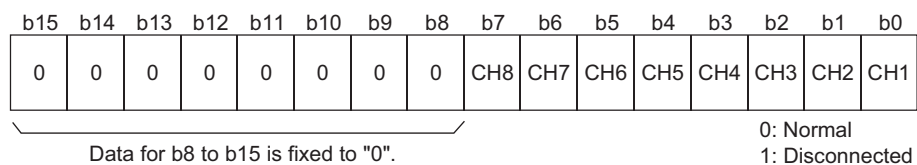

- (5) When Operating condition setting request (Y9) or Error clear request (YF) is turned ON, this flag will be cleared.
- (6) The following table shows the relationship between the Disconnection detection flag and conversion enable/disable setting.

Table 3.13 Relationship between the Disconnection detection flag and conversion enable/disable setting

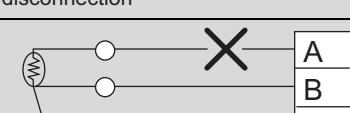
Connection status	Conversion enable/disable setting	Disconnection detection flag
 <p>Without disconnection</p>	Enable	OFF
	Disable	
 <p>With disconnection</p>	Enable	ON
	Disable	OFF
<div style="display: flex; flex-direction: column; align-items: center;"> <div style="border: 1px solid black; padding: 2px; margin-bottom: 2px;">A</div> <div style="border: 1px solid black; padding: 2px; margin-bottom: 2px;">B</div> <div style="border: 1px solid black; padding: 2px;">b</div> </div> <p>Without connection</p>	Enable	ON
	Disable	OFF

☒ POINT

- (1) Always set "Disable" for any channel where no RTD is connected.
If "Enable" is set, the bit of the corresponding channel in the Disconnection detection flag (Un\G49) turns ON (changes to "1").
 - (2) When the Disconnection detection flag (Un\G49) turns ON (changes to "1"), a value to be stored in the Measured temperature value can be selected from "Up scale", "Down scale" or "Given value". (Refer to Section 3.2.2.)
When connection is restored, updating of the measured temperature value will be restarted.
 - (3) For wiring of RTD, refer to Section 4.4.
 - (4) For troubleshooting of disconnection detection, refer to Section 8.2.7.
-

3.4.15 CH□ Scaling value (Un\G50 to Un\G57)

- (1) Measured temperature values within the scaling range set in the CH□ Scaling range upper/lower limit values (Un\G62 to Un\G77) are scaled to the scaling width set in the CH□ Scaling width upper/lower limit values (Un\G78 to Un\G93), and the result is stored.
- (2) The following is how to calculate the scaling value.

$$\text{Scaling value} = \frac{(\text{scaling width upper limit value} - \text{scaling width lower limit value}) \times (\text{measured temperature value} - \text{scaling range lower limit value})}{\text{scaling range upper limit value} - \text{scaling range lower limit value}} + \text{scaling width lower limit value}$$

[Example] To scale a temperature to percent

When the CH1 measured temperature value of 360°C (measured temperature value = 3600) is scaled at the following settings:

Scaling range: -100 to 500°C (lower limit value = -1000, upper limit value = 5000)

Scaling width: 0 to 100% (lower limit value = 0, upper limit value = 100)

$$\text{Scaling value} = (100 - 0) \times \frac{3600 - (-1000)}{5000 - (-1000)} + 0 = 76.666666 \dots$$

Fractional portion is rounded off.

$$= 77[\%]$$

Stores into buffer memory address 50.

POINT

- (1) If the upper limit value is less than the lower limit value in the settings of the CH□ Scaling range upper/lower limit values (Un\G62 to Un\G77) or the CH□ Scaling width upper/lower limit values (Un\G78 to Un\G93), it will not result in an error and the scaling value calculated with the expression above will be output.
- (2) When the measured temperature is out of the range set in the Scaling range upper/lower limit values, the value set in the Scaling width upper limit value or lower limit value is stored into this buffer memory.

3.4.16 Scaling valid/invalid setting (Un\G58)

(1) This area is for setting the scaling function valid/invalid status for each channel.

(2) The default value is set to "Invalid" for all channels.

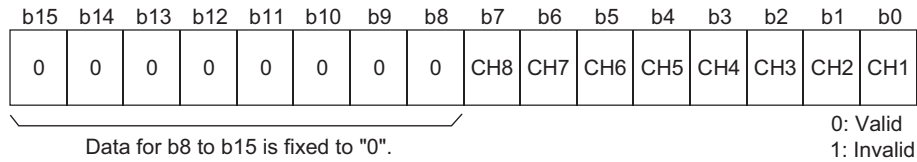

(3) To activate the scaling function, turning ON/OFF Operating condition setting request (Y9) after setting this area is required.

(4) Program example with a condition of the following is below.

Scaling range: -100°C to 500°C (lower limit value = -1000, upper limit value = 5000)

Scaling width: 0 to 100% (lower limit value = 0, upper limit value = 100)

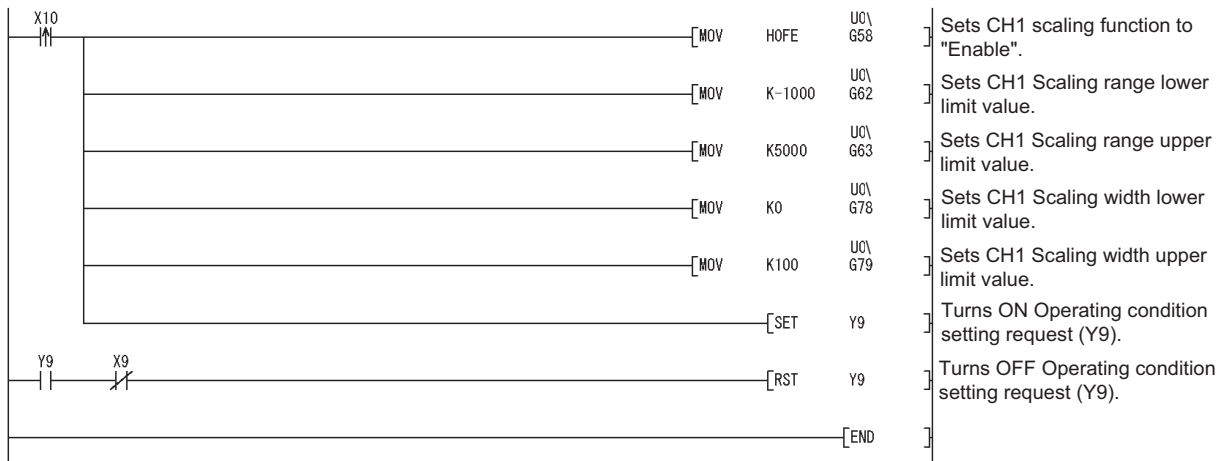

3.4.17 CH□ Scaling range upper/lower limit values (Un\G62 to Un\G77)

- (1) A scaling range of measured temperature values is set for each channel in units of 0.1°C.
- (2) The default value is set to "0".
- (3) Settable scaling range is -32768 to 32767.
- (4) To activate the setting, turning ON/OFF Operating condition setting request (Y9) is required.

☒ POINT

- (1) When the measured temperature is out of the range set in the Scaling range upper/lower limit values, the value set in the Scaling width upper limit value or lower limit value is stored into the CH□ Scaling value (Un\G50 to Un\G57).
- (2) Set "Valid" in the Scaling valid/invalid setting (Un\G58).
When "Disable" is set, the settings of CH□ Scaling range upper/lower limit values (Un\G62 to Un\G77) take no effect.
- (3) If the same value is set for the upper limit and the lower limit, an error (error code: 91□) occurs on the corresponding channel. Then, Error flag (XF) turns ON and the module operates with the setting before the error occurrence.

3.4.18 CH□ Scaling width upper/lower limit values (Un\G78 to Un\G93)

- (1) A width for scaling conversion is set for each channel.
- (2) The default value is set to "0".
- (3) Settable scaling range is -32768 to 32767.
- (4) To activate the setting, turning ON/OFF Operating condition setting request (Y9) is required.

☒ POINT

- (1) When "Invalid" is set in the Scaling valid/invalid setting (Un\G58), the settings of CH□ Scaling width upper/lower limit values (Un\G78 to Un\G93) take no effect.
- (2) If the same value is set for the upper limit and the lower limit, an error (error code: 91□) occurs on the corresponding channel. Then, Error flag (XF) turns ON and the module operates with the setting before the error occurrence.

3.4.19 CH□ Process alarm upper/lower limit values (Un\G94 to Un\G125)

- (1) Process alarm upper upper limit value, upper lower limit value, lower upper limit value, and lower lower limit value are set.
- (2) A range of measured temperature values is set for each channel in units of 0.1°C.
- (3) Settable range and default value differ according to the RTD type and measurement range.

Table 3.14 Process alarm settable range and default value

RTD type (Measurement range)	Default value				Settable temperature range (Accuracy guarantee range) (in units of 0.1°C)
	Process alarm lower upper limit value (in units of 0.1°C)	Process alarm lower lower limit value (in units of 0.1°C)	Process alarm upper upper limit value (in units of 0.1°C)	Process alarm upper lower limit value (in units of 0.1°C)	
Pt100 (-200 to 850°C)	-2000		8500		-2000 to 8500
Pt100 (-20 to 120°C)	-200		1200		-200 to 1200
Pt100 (0 to 200°C)	0		2000		0 to 2000
JPt100 (-180 to 600°C)	-1800		6000		-1800 to 6000
JPt100 (-20 to 120°C)	-200		1200		-200 to 1200
JPt100 (0 to 200°C)	0		2000		0 to 2000
Ni100 (-60 to 180°C)	-600		1800		-600 to 1800

- (4) To activate the setting, turning ON/OFF Operating condition setting request (Y9) is required.

- (5) For details on process alarm, refer to Section 3.2.3.

☒ POINT

- (1) If any of the following values are set, an error (error code: 6△□) occurs. Then, Error flag (XF) turns ON and the module operates with the setting before the error occurrence.
 - A value out of the above settable range.
 - A value that does not satisfy the following condition:
 Process alarm lower lower limit value \leq lower upper limit value \leq upper lower limit value \leq upper upper limit value
- (2) When "Disable" is set in the Warning output enable/disable setting (Un\G46), the settings of CH□ Process alarm upper/lower limit values (Un\G94 to Un\G125) take no effect.

3.4.20 CH□ Rate alarm warning detection period (Un\G126 to Un\G133)

- (1) The number of conversion periods to check a change in measured temperature values is set for each channel.
- (2) Settable range is 1 to 6000 (times).
- (3) The default value is set to "0".
- (4) To activate the setting, turning ON/OFF Operating condition setting request (Y9) is required.
- (5) For details on rate alarm, refer to Section 3.2.3.

☒ POINT

- (1) When a value out of the above setting range is set, an error (error code: 70□) occurs on the corresponding channel. Then, Error flag (XF) turns ON and the module operates with the setting before the error occurrence.
- (2) Set "Enable" in the Warning output enable/disable setting (Un\G46). When "Disable" is set, the settings of CH□ Rate alarm warning detection period (Un\G126 to Un\G133) take no effect.

3.4.21 CH□ Rate alarm upper/lower limit values (Un\G134 to Un\G149)

- (1) A change portion for measured temperature values is set for each channel.
- (2) Settable range is -32768 to 32767 (-3276.8 to 3276.7°C) and set the value in units of 0.1°C.

[Example]

When setting the rate alarm upper limit value to 30°C, store "300" into the buffer memory.

- (3) To activate the setting, turning ON/OFF Operating condition setting request (Y9) is required.
- (4) For details on rate alarm, refer to Section 3.2.3.

3.4.22 Mode switching setting (Un\G158 and Un\G159)

This area is used to switch the mode between normal mode and offset/gain setting mode. The mode can be switched without resetting the programmable controller CPU.

- (1) The setting value of the switching target mode is set.
- (2) To switch the mode, turning ON/OFF Operating condition setting request (Y9) after setting the value is required.
- (3) When the mode is switched, this area is cleared to "0" and Operating condition setting completion flag (X9) turns OFF.
After confirming that Operating condition setting completion flag (X9) has turned OFF, turn OFF Operating condition setting request (Y9).

Table 3.15 Switching target mode and setting value

Switching target mode	Setting Value	
	Buffer memory address 158	Buffer memory address 159
Normal mode	0964H	4144H
Offset/gain setting mode	4144H	0964H

☒ POINT

If a value other than the setting value above is written, mode switching is not performed and only the operating condition is changed.

3.4.23 Conversion setting for disconnection detection (Un\G164 and Un\G165)

- (1) The value to be stored in the CH□ Measured temperature value (Un\G11 to Un\G18) when disconnection state is confirmed is selected from "Up scale", "Down scale" or "Given value".
- (2) When "Up scale"(0H) is selected, up-scale of the currently set range is stored in the CH□ Measured temperature value (Un\G11 to Un\G18).
- (3) When "Down scale" (1H) is selected, down-scale of the currently set range is stored in the CH□ Measured temperature value (Un\G11 to Un\G18).
- (4) When "Given value"(2H) is selected, the value set in the CH□ Conversion setting value for disconnection detection (Un\G166 to Un\G173) is stored in the CH□ Measured temperature value (Un\G11 to Un\G18).
- (5) The default value is set to "Down scale".

Un\G164 (Conversion setting for disconnection detection CH1-4)	b15	to	b12	b11	to	b8	b7	to	b4	b3	to	b0
	CH4			CH3			CH2			CH1		
Un\G165 (Conversion setting for disconnection detection CH5-8)	CH8			CH7			CH6			CH5		

Measured temperature value at the time of disconnection detection	Setting value
Up scale	0H
Down scale	1H
Given value	2H

- (6) To activate the setting, turning ON/OFF Operating condition setting request (Y9) is required.
- (7) For details, refer to Section 3.2.2.

☒ POINT

If a value out of the setting range is set, the module operates with the default setting, "Down scale".

3.4.24 CH□ Conversion setting value for disconnection detection (Un\G166 to Un\G173)

- (1) When "Given value" (2H) is set in the Conversion setting for disconnection detection (Un\G164 and Un\G165), the value set in this area is stored in the CH□ Measured temperature value (Un\G11 to Un\G18) at the time of disconnection detection.
When "Up scale" (0H) or "Down scale" (1H) is set in the Conversion setting for disconnection detection, the settings in these area take no effect.
- (2) Setting range is from -32768 to 32767 (0000H to FFFFH) (in units of 0.1°C).

[Example]

When setting the value to 0.3°C Store "3" in the buffer memory.

- (3) The default value is set to "0".
- (4) To activate the setting, turning ON/OFF Operating condition setting request (Y9) is required.

3.4.25 Factory default offset/gain values, User range settings offset/gain values, User range settings resistance offset/gain values (Un\G190 to Un\G253)

- (1) **This area is related to the user range save/restore function to re-set the offset/gain easily at online module change.**
- (2) **When the offset/gain setting values of the user range setting are restored, the data to be used are stored.**

The data are stored (saved) in the following cases.

 - When writing initial setting by the utility
 - When setting the operating condition (Y9 turns from OFF to ON^{*1})
 - When writing the offset/gain values in the offset/gain setting mode (YA turns from OFF to ON)

* 1 The data are not saved when a setting value has been written in the Mode switching setting (Un\G158 and Un\G159).
- (3) **To restore the offset/gain values of the user range setting, set the data saved in this area to the corresponding area of the restoring target module.**
- (4) **Save buffer memory data during online module change in the following procedure.**
 - 1) Turn OFF to ON Operating condition setting request (Y9).
 - 2) Compare the values of the Factory default offset/gain values, the User range settings offset/gain values, and the User range settings resistance offset/gain values (Un\G190 to Un\G253) to the values in the range reference table. For the range reference table, refer to Section 7.4.
 - 3) When the values are appropriate, take down the buffer memory data compared.
- (5) **For details on online module change, refer to CHAPTER 7.**

☒ POINT

This area is not used for offset/gain setting.
For offset/gain setting, refer to Section 4.6.

CHAPTER4 PROCEDURES AND SETTINGS BEFORE SYSTEM OPERATION

4.1 Handling Precautions

- (1) Do not drop or give a strong impact to the case.
- (2) Do not remove the printed-circuit board of the module from the case. Doing so may cause a failure.
- (3) Be careful to prevent foreign matters such as cutting chips or wire chips from entering the module. Such foreign matter can cause a fire, failure, or malfunction.
- (4) A protective film is attached to the module top to prevent foreign matter such as wire chips from entering the module during wiring. Do not remove the film during wiring. Be sure to remove it for heat dissipation before system operation.
- (5) Tighten the screws such as module fixing screws within the following ranges. Loose screws may cause short circuits, failures, or malfunctions.

Table 4.1 Tightening torque

Screw	Tightening torque range
Module fixing screw (M3 screw)	0.36 to 0.48N·m
Connector screw (M2.6 screw)	0.20 to 0.29N·m

- (6) To mount the module, while pressing the module mounting lever located in the lower part of the module, fully insert the module fixing projection into the hole in the base unit and press the module until it snaps into place. Incorrect module mounting may cause a malfunction, failure, or drop of the module.
- (7) Always make sure to touch the grounded metal to discharge the electricity charged in the body, etc., before touching the module. Failure to do so may cause a failure or malfunctions of the module.

4.1.1 Fixing module with module fixing bracket

Fix the Q68RD3-G with a module fixing bracket after it is mounted to the base unit.

POINT

Make sure that the module fixing bracket is hooked on the 3rd slit viewed from the front of the Q68RD3-G. Then, tighten the module fixing screw within the specified torque range.

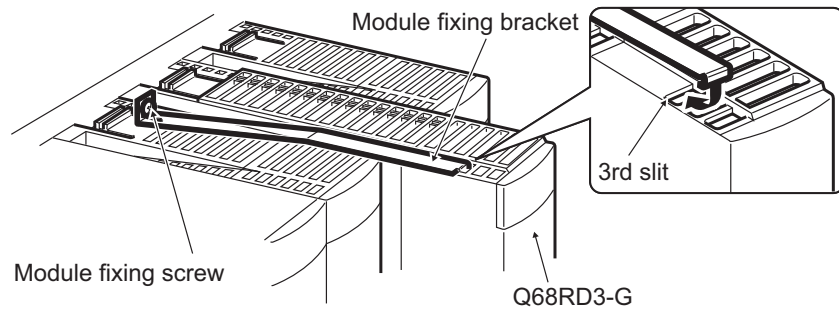

4.2 Procedures and Settings before System Operation

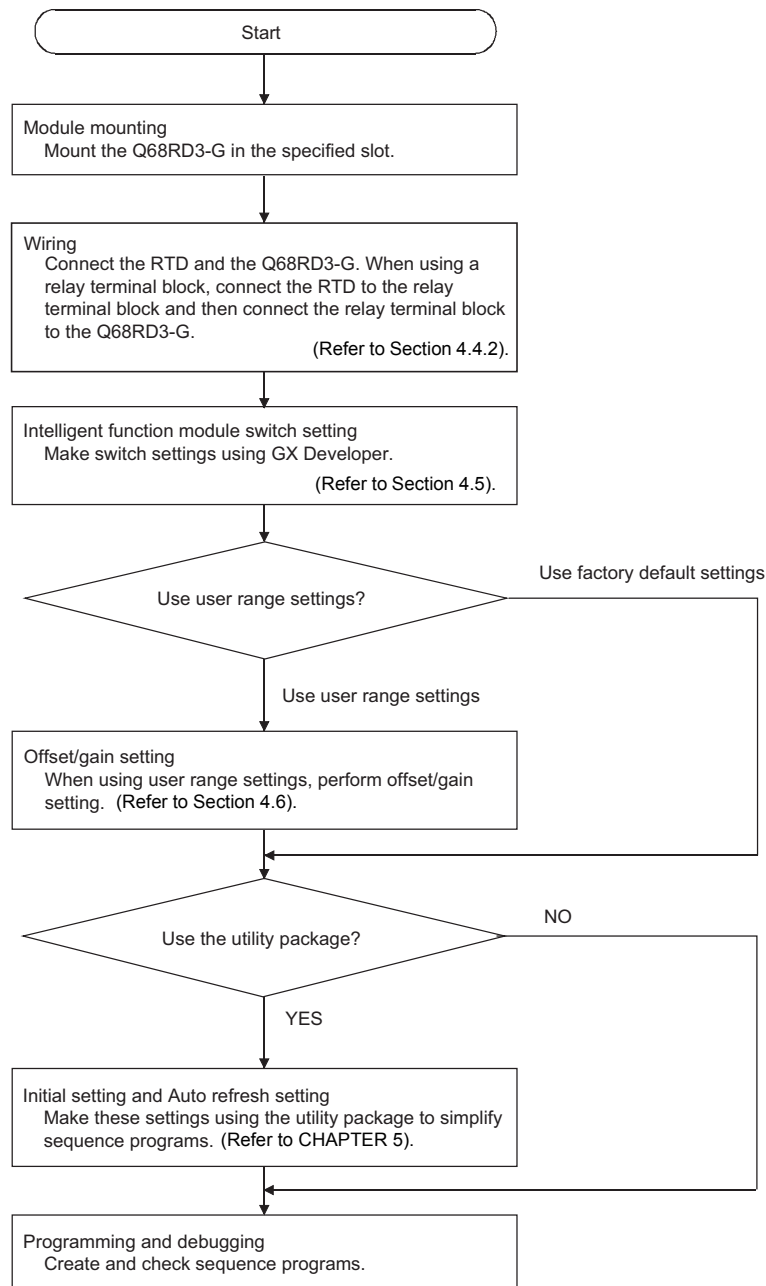

4.3 Part Names

This section describes each part name of the Q68RD3-G.

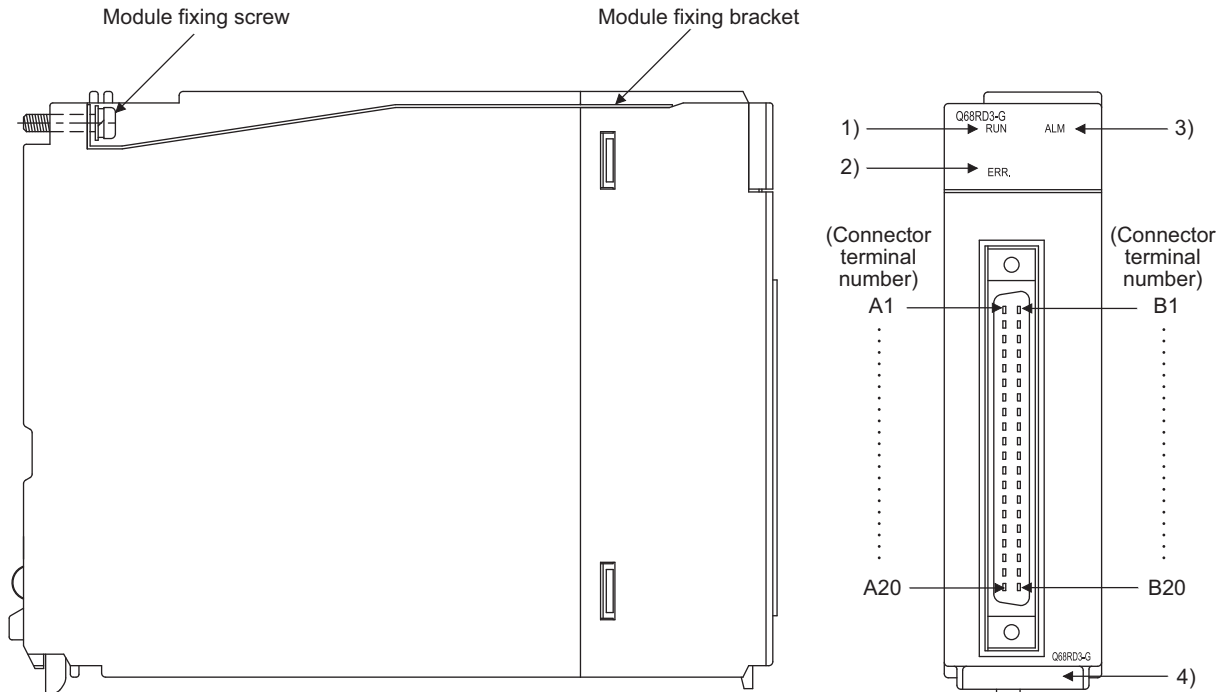

Table 4.2 Part name

Number	Name	Description
1)	RUN LED*1	Indicates the operating status of the Q68RD3-G. On: Normal operation Flashing: Offset/gain setting mode Off: 5V power supply interrupted, watchdog timer error occurred, or online module change enabled
2)	ERR. LED	Indicates the error status of the Q68RD3-G. On: Error occurred Flashing: Switch setting error occurred The setting value of the intelligent function module switch 5 is other than 0. Off: Normal operation
3)	ALM LED	Indicates the warning status of the Q68RD3-G. On: Warning (process alarm, rate alarm) occurred (Refer to Section 3.4.13.) Flashing: Disconnection detected Off: Normal operation
4)	Serial No. display	Displays the serial No. of the Q68RD3-G

* 1 When the module is mounted on a MELSECNET/H remote I/O station, the RUN LED stays off until a data link starts normally, even after the power is turned on. The RUN LED turns on once a data link starts.

Table 4.3 Signal name

Terminal number	Signal name	Terminal number	Signal name
A1	CH1 A1	B1	CH1 B1
A2	CH1 b1	B2	—
A3	—	B3	CH2 b2
A4	CH2 A2	B4	CH2 B2
A5	—	B5	—
A6	CH3 A3	B6	CH3 B3
A7	CH3 b3	B7	—
A8	—	B8	CH4 b4
A9	CH4 A4	B9	CH4 B4
A10	—	B10	—
A11	CH5 A5	B11	CH5 B5
A12	CH5 b5	B12	—
A13	—	B13	CH6 b6
A14	CH6 A6	B14	CH6 B6
A15	—	B15	—
A16	CH7 A7	B16	CH7 B7
A17	CH7 b7	B17	—
A18	—	B18	CH8 b8
A19	CH8 A8	B19	CH8 B8
A20	—	B20	—

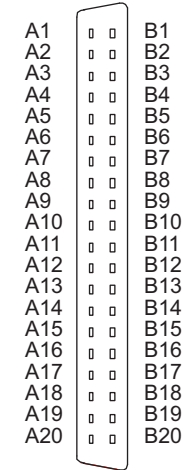

Seen from the front of the module

* 1 For actual wiring, refer to Section 4.4.2 External wiring.

(1) Connector for external wiring

The connectors for use with the Q68RD3-G should be purchased separately by the user. The following tables show the connector types and the crimp-contact tool.

(a) Connector types*¹

Type	Model name	Applicable wire size
Soldering type (straight out)	A6CON1	0.3mm ² (22 AWG) (stranded)
Crimp-contact type (straight out)	A6CON2	0.088mm ² to 0.24mm ² (28 to 24 AWG) (stranded)
Soldering type (straight out/diagonal out)	A6CON4	0.3mm ² (22 AWG) (stranded)

* 1 The A6CON3 (pressure-displacement type, straight out) connector cannot be used for the Q68RD3-G.

(b) Crimp-contact tool

Type	Model name	Applicable wire size	Contact
Crimp-contact tool	FCN-363T-T005/H	0.088mm ² to 0.24mm ² (28 to 24 AWG)	FUJITSU COMPONENT LIMITED www.fcl.fujitsu.com/en

4.4 Wiring

This section describes the wiring precautions and module connection example.

4.4.1 Wiring precautions

External wiring that is less susceptible to noise is required as a condition of configuring a highly-reliable system and making full use of the capabilities of the Q68RD3-G. Precautions for external wiring are described below.

- (1) Use separate cables for the AC control circuit and the external input signals of the Q68RD3-G to avoid the influence of the AC side surges and inductions.
- (2) Always place a RTD at least 100mm away from the main circuit cables and AC control circuit lines. Fully keep it away from high-voltage cables and circuits, which include high frequency waves, such as an inverter's load circuit. Not doing so will cause the module more susceptible to noises, surges, and inductions.
- (3) The following wiring is required for the product to comply with the EMC and Low Voltage Directives.

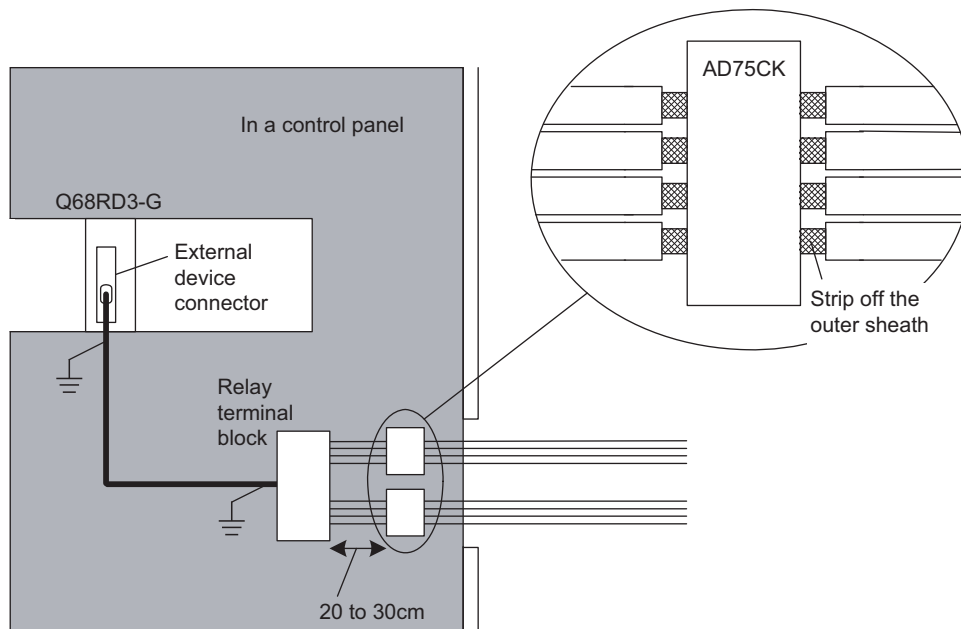

- (a) Use shielded cables for every external wiring and use the AD75CK cable clamp to ground to the panel. AD75CK can ground four cables together when using cables with outer diameter of about $\phi 7\text{mm}$. Use shielded cabled between the external device connector and the relay terminal block, and ground it to the control panel. The cable must be 3m or shorter.
- (b) Before touching the relay terminal block, always touch the grounded metal to discharge the electricity charged in the body.

4.4.2 External wiring

(1) Wiring procedure

- 1) Install a relay terminal block.
- 2) Connect a RTD and the relay terminal block.
Wire Q68RD3-G to the relay terminal block using an external device connector.

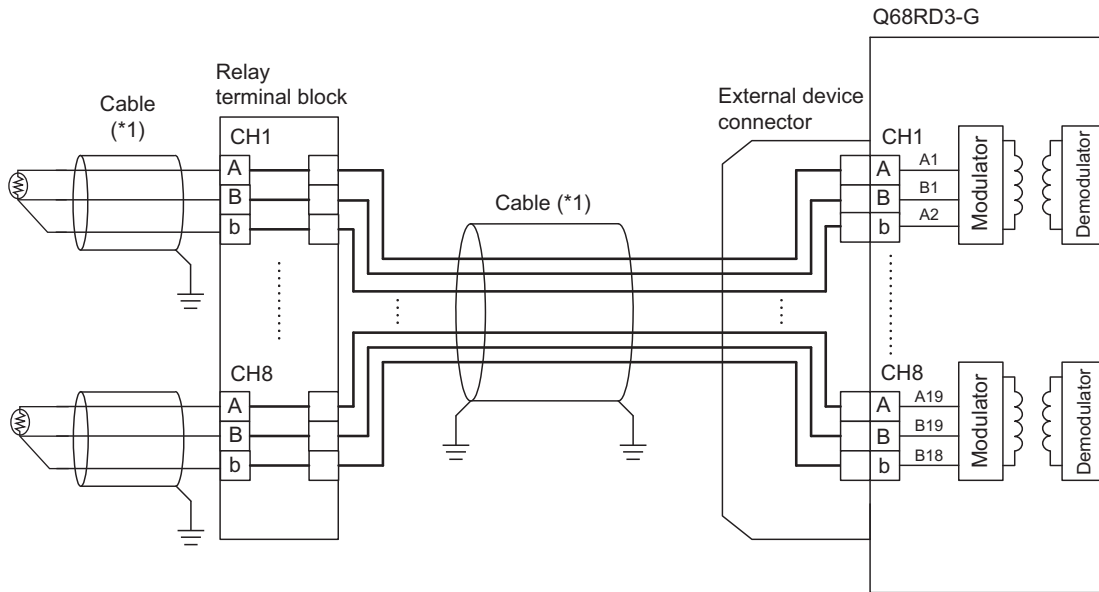

* 1 Always use shielded cables.
In addition, always ground the shield.

(2) Specifications when an RTD is connected

Satisfy the following conditions when connecting an RTD to the Q68RD3-G.

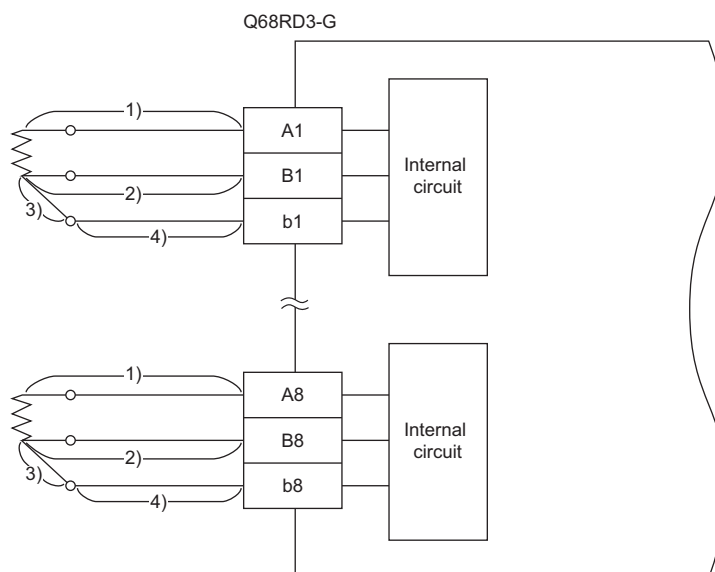

- Make sure that the total of conductor resistance values for 1), 3), and 4) is 2kΩ or smaller.

- Make sure that the total of conductor resistance values for 2), 3), and 4) is 2kΩ or smaller.
- Make sure that the difference between the conductor resistance values for 1) and 2) is 10Ω or smaller.

(3) When a connector/terminal block converter module is used

A connector/terminal block converter module for the Q68RD3-G and dedicated cables are available.

To use the connector/terminal block converter module, wire modules as shown below.

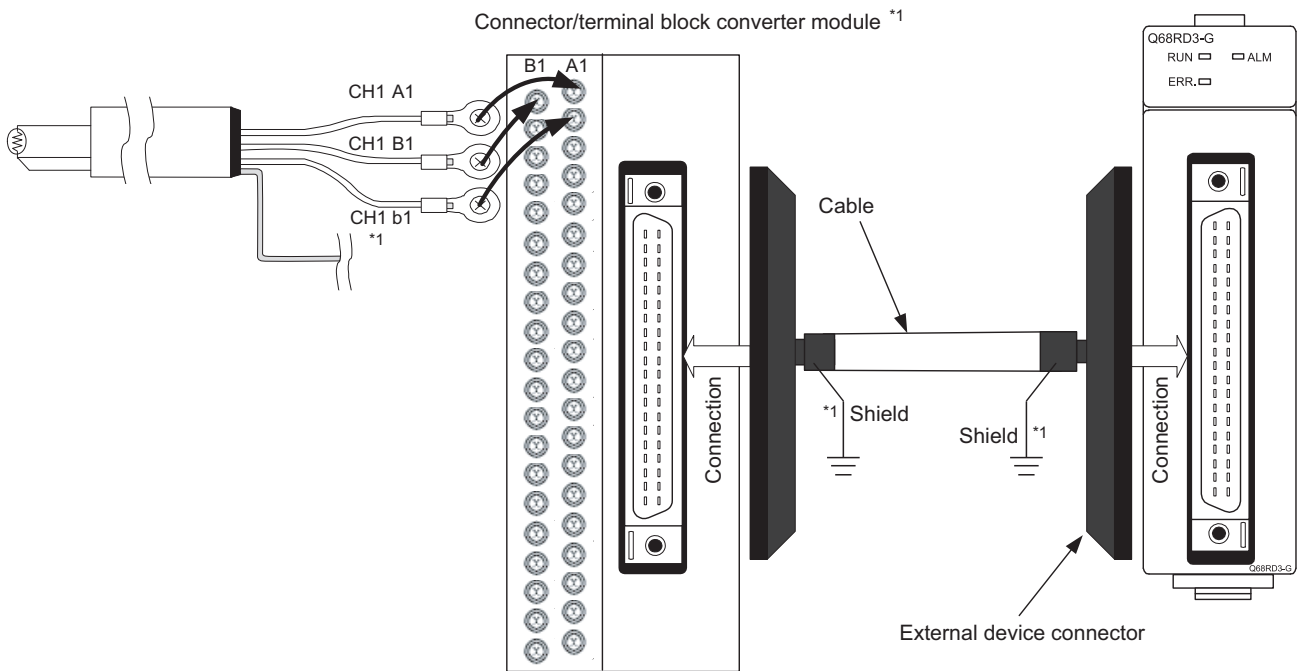

* 1 Always use a shielded cable. In addition, always ground the shields.

Table 4.4 List of the model names

Product name	Model name	Remarks	Manufacturer
Connector/terminal block converter module	FA-LTB40RD3G	-	Mitsubishi Electric Engineering Co., Ltd.
Dedicated cable	FA-CBL05Q68RD3G	Cable length: 0.5m	
	FA-CBL10Q68RD3G	Cable length: 1.0m	
	FA-CBL20Q68RD3G	Cable length: 2.0m	
	FA-CBL30Q68RD3G	Cable length: 3.0m	

For inquiries related to the products or your order, please consult your local Mitsubishi Electric sales office or representative.

4.5 Intelligent Function Module Switch Setting



The intelligent function module switches are set on the I/O assignment tab of PLC parameter in GX Developer.

(1) Setting item

There are five intelligent function module switches, Switch 1 to 5. Values are set with 16-bit data.

The default value when not setting the intelligent function module switches is "0" for all Switch 1 to 5.

Table 4.5 Intelligent function module switch setting

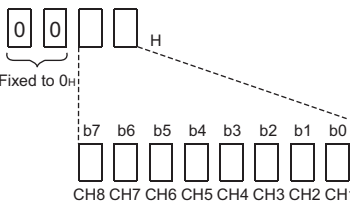
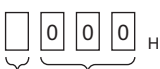
		Setting item																					
Switch 1	Measurement range setting (CH1 to CH4) 	<table border="1"> <thead> <tr> <th>RTD</th> <th>Measurement range</th> <th>Setting value</th> </tr> </thead> <tbody> <tr> <td rowspan="3">New JIS (Pt100)</td> <td>-200 to 850°C</td> <td>0_H</td> </tr> <tr> <td>-20 to 120°C</td> <td>1_H</td> </tr> <tr> <td>0 to 200°C</td> <td>4_H</td> </tr> <tr> <td rowspan="3">Old JIS (JPT100)</td> <td>-180 to 600°C</td> <td>2_H</td> </tr> <tr> <td>-20 to 120°C</td> <td>3_H</td> </tr> <tr> <td>0 to 200°C</td> <td>5_H</td> </tr> <tr> <td>Ni100</td> <td>-60 to 180°C</td> <td>8_H</td> </tr> </tbody> </table>	RTD	Measurement range	Setting value	New JIS (Pt100)	-200 to 850°C	0 _H	-20 to 120°C	1 _H	0 to 200°C	4 _H	Old JIS (JPT100)	-180 to 600°C	2 _H	-20 to 120°C	3 _H	0 to 200°C	5 _H	Ni100	-60 to 180°C	8 _H	Setting a value other than above results in a range setting error (error code: 10□) and measured temperature is not converted. (□ indicates the error corresponding channel number.)
			RTD	Measurement range	Setting value																		
New JIS (Pt100)	-200 to 850°C	0 _H																					
	-20 to 120°C	1 _H																					
	0 to 200°C	4 _H																					
Old JIS (JPT100)	-180 to 600°C	2 _H																					
	-20 to 120°C	3 _H																					
	0 to 200°C	5 _H																					
Ni100	-60 to 180°C	8 _H																					
Switch 2	Measurement range setting (CH5 to CH8) 																						
Switch 3	Offset/gain setting 	0: Factory default setting 1: User range setting																					
Switch 4	Mode setting 	0 _H : Normal mode 1 _H to F _H ¹ : Offset/gain setting mode																					
Switch 5		0 _H : Fixed ^{*2}																					

* 1 Setting any value within the setting range will provide the same operation.

When the setting range is 1_H to F_H, set "1_H" for example.

* 2 Setting a value other than "0_H" results in an error.

(2) Operating procedure

Make settings on the I/O assignment tab of PLC parameter in GX Developer.

(a) I/O assignment tab

Set the following for the slot in which the Q68RD3-G is mounted.

The "Type" setting is mandatory, but other items are optional. Set them as needed.

Type : Select "Intelli."

Model name : Enter the module model name.

Points : Select "16points".

StartXY : Enter the start I/O number of the Q68RD3-G.

Detailed setting: Specify the control programmable controller of the Q68RD3-G.

It is unnecessary to set the "Error time output mode" and "H/W error time PLC operation mode" since these settings are invalid for the Q68RD3-G.

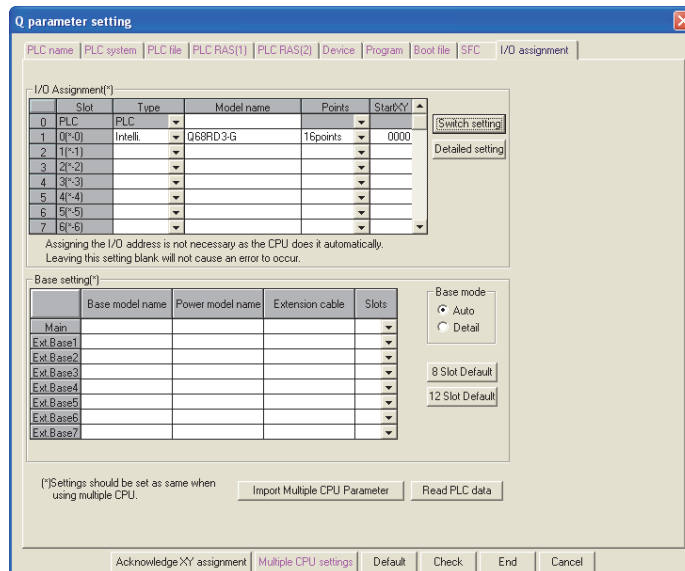

(b) Switch setting for intelligent function module screen

Click the **Switch setting** button on the I/O assignment tab to display the screen shown below, then make settings for Switch 1 to 5.

The switches can be set easily if values are entered in hexadecimal. Change the "Input format" to "HEX." (hexadecimal) and then enter setting values.

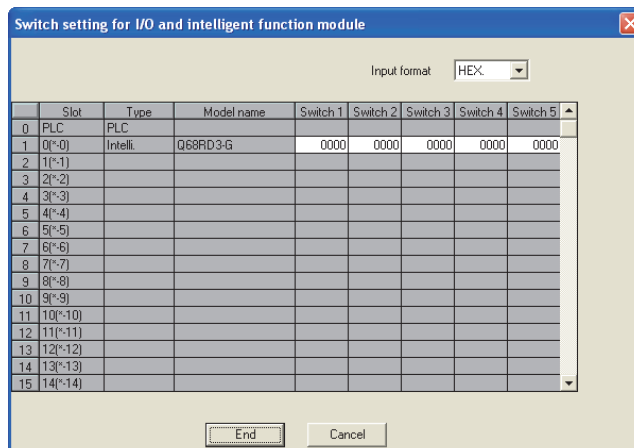

4.6 Offset/Gain Setting

Set offset/gain setting values in the following procedure.

When factory default settings are used, offset/gain setting is not required.

If the utility package is installed, set offset/gain setting values according to the procedure described in Section 5.6.2.

(1) Setting procedure

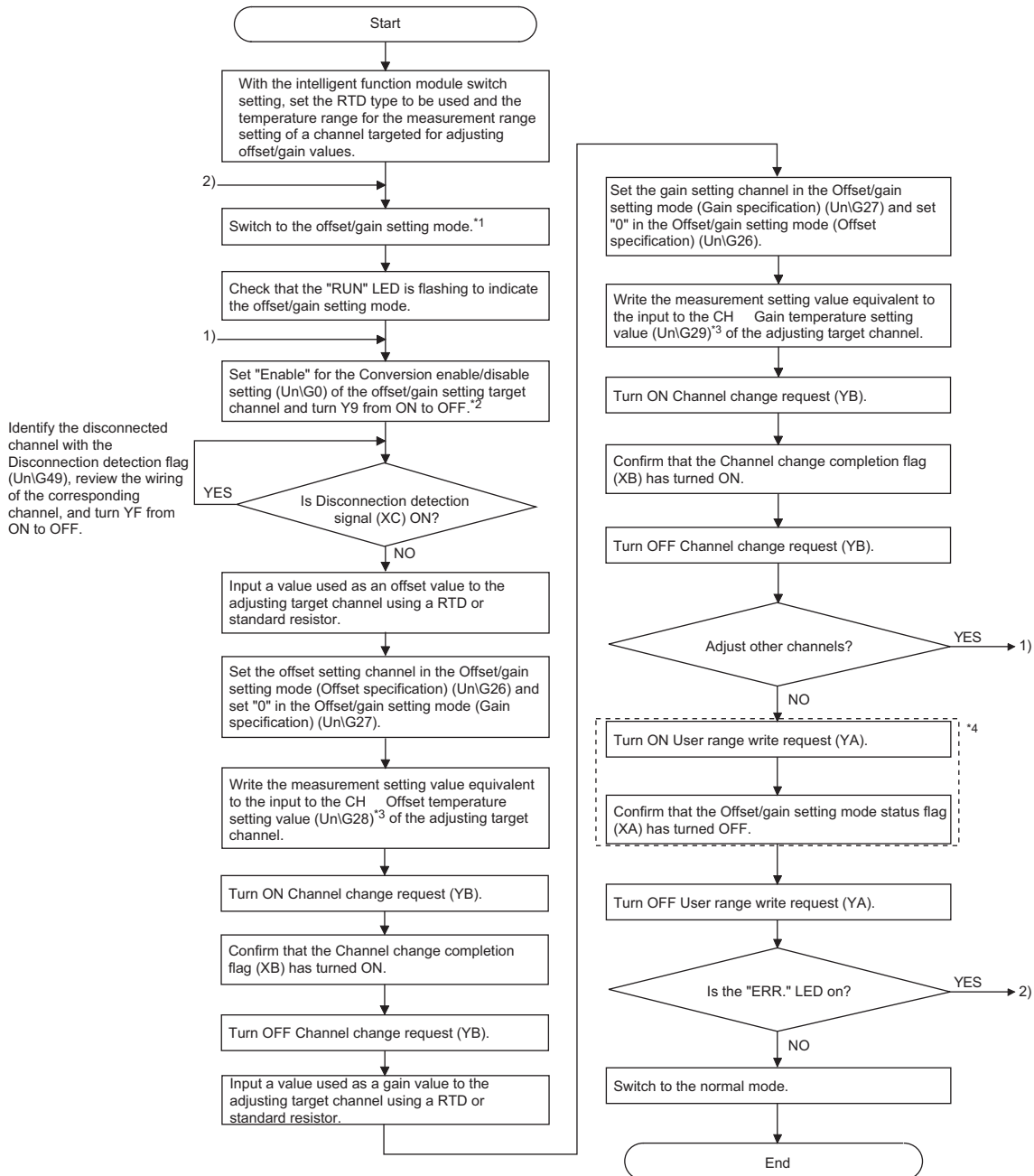

- * 1 The following table shows the mode switching method (normal mode → offset/gain setting mode → normal mode).

Table 4.6 Mode switching method

Mode switching method	Reference
Dedicated instruction (G(P).OFFGAN)	(2)(a) in this section
Setting in the Mode switching setting (Un\G158, Un\G159) and turning Operating condition setting request (Y9) from OFF to ON	(2)(b) in this section
Intelligent function module switch setting (After setting the intelligent function module switches, power OFF → ON or reset the programmable controller CPU.)	Section 4.5, (2)(c) in this section

- * 2 Always set "Disable" to the Conversion enable/disable setting of unused channels or channels not targeted for the offset/gain setting.
If all channels are set to "Enable", the Disconnection detection flag (Un\G49) of channels that are not connecting a RTD turns ON (changes to "1").
- * 3 Only buffer memory address of channel 1 is described in the chart. For buffer memory addresses of other channels, refer to Section 3.4.1 Buffer memory assignment.
- * 4 Do not perform the operations below during the steps indicated with *4. If they are performed, the data inside a flash memory will have a problem, and the Q68RD3-G may not operate normally.
- Powering off the programmable controller CPU
 - Resetting the programmable controller CPU

POINT

- (1) Perform offset/gain setting in the actual operating status.
 - (2) Offset/gain values are stored in the Flash memory of the Q68RD3-G by turning ON User range write request (YA). These values are not erased even at power-off. To prevent unnecessary write to the Flash memory, an error (error code: 162) occurs when values are written 26 times continuously.
 - (3) Set the offset/gain values within the range where the following conditions are satisfied.
(Gain value) - (Offset value) > 0.1[°C]
Set the offset/gain temperature setting values within the range where the following conditions are satisfied.
(Gain temperature setting value) - (Offset temperature setting value) > 0.1[°C]
 - (4) When User range write request (YA) is turned ON, consistency checks, for offset value and gain value, and for offset temperature setting value and gain temperature setting value, are executed.
If an error occurs on any channel, offset/gain values are not written to the module.
Check the value in the Error code (Un\G19) and take a corrective action.
Then, perform offset/gain setting again.
 - (5) Offset/gain setting can be performed on multiple channels at the same time. However, set the offset/gain channels separately.
If the offset/gain channels are set at the same time, an error (error code: 500) occurs.
 - (6) It takes approximately 7 seconds before Channel change completion flag (XB) turns ON after turning ON Channel change request (YB). During this period, input to channels targeted for offset/gain setting must be constant. In addition, if disconnection state is detected during this period, Channel change completion flag (XB) turns ON earlier and an error (error code: 51□) occurs at the same time. If this occurs, perform offset/gain setting again after connection is restored.
 - (7) If an error (error code: 51□) described at (6) occurs while performing offset/gain setting simultaneously on multiple channels, values are not set only for the disconnected channel but also normally-connected channels. Therefore, perform offset/gain setting again for all adjusting target channels after connection is restored.
 - (8) Module ready (X0) turns from OFF to ON when the offset/gain setting mode is switched to the normal mode by the dedicated instruction (G(P).OFFGAN) or the setting in the Mode switching setting (Un\G158 and Un\G159).
Note that initial setting processing will be executed if there is a sequence program that performs initial settings when Module ready (X0) turns ON.
-

(2) Program examples

The program in the dotted area of (a) is common to all (a), (b), and (c).
In these examples, X/Y0 to X/YF are used as I/O numbers of the Q68RD3-G.

Table 4.7 List of devices

Device	Function
M0	Mode switching
M1	Channel selection
M2	Channel conversion enabling
M3	Offset setting
M4	Gain setting
M5	Channel change instruction
M6	Offset/gain setting value write command to module
M50	Switching to the offset/gain setting mode
M51	Switching to the normal mode
D0	Dedicated instruction (G(P).OFFGAN) setting value storage device
D1	Channel specification storage device
D2	
D3	Offset temperature setting value storage device
D4	Gain temperature setting value storage device

(a) When switching the mode using the dedicated instruction (G(P).OFFGAN)

In this program example, the mode is switched to the offset/gain setting mode by the dedicated instruction (G(P).OFFGAN), offset/gain setting target channels are set, and the offset/gain values are written to the Q68RD3-G. Then, the mode is switched back to the normal mode.

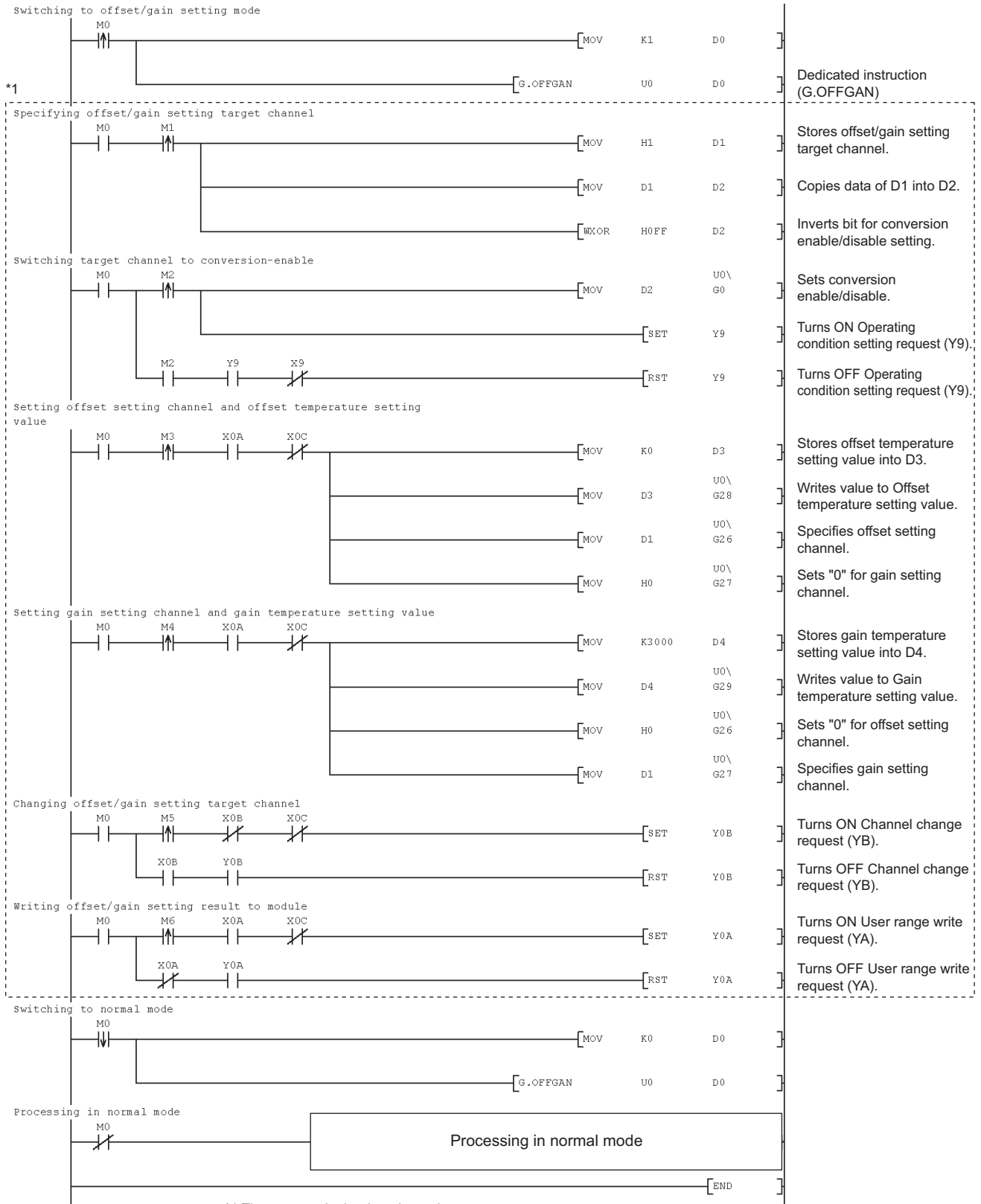

4 PROCEDURES AND SETTINGS BEFORE SYSTEM OPERATION

(b) When switching the mode using the setting in the Mode switching setting (Un\G158 and Un\G159) and Operating condition setting request (Y9)

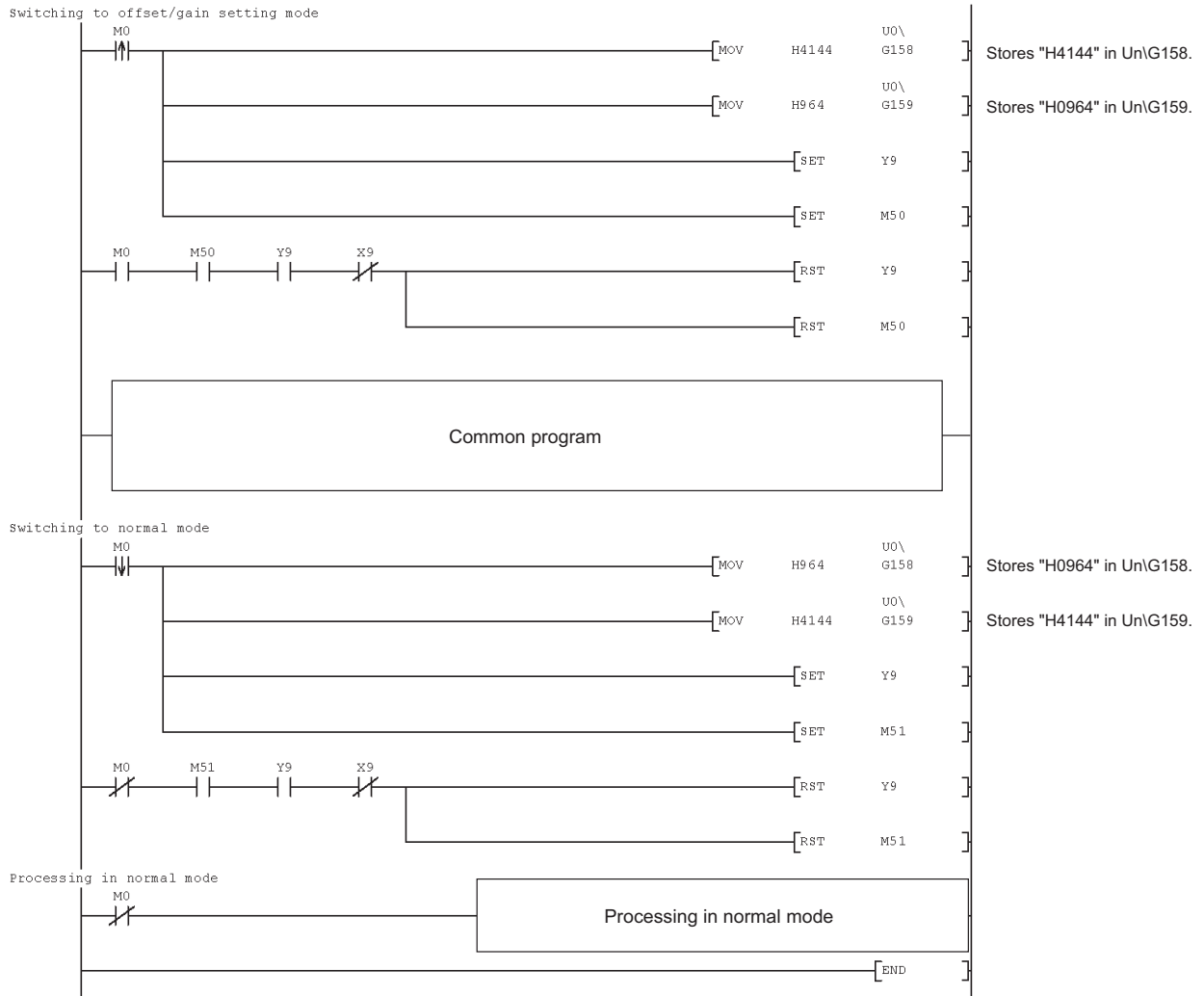

(c) When switching the mode using the intelligent function module switch setting
Only the common program is required.

CHAPTER5 UTILITY PACKAGE (GX Configurator-TI)

5.1 Utility Package Functions

Table 5.1 lists the utility package functions.

Table 5.1 List of utility package (GX Configurator-TI) functions (1/2)

Function	Description	Reference
Initial setting	(1) Makes initial setting of the following items, which are required to operate the Q68RD3-G, for each channel. <ul style="list-style-type: none"> •Conversion enable/disable setting •Averaging processing selection •Time/count/moving average/time constant setting •Process alarm warning output enable/disable setting •Setting range •Process alarm lower lower limit value •Process alarm lower upper limit value •Process alarm upper lower limit value •Process alarm upper upper limit value •Rate alarm warning output enable/disable setting •Rate alarm warning detection period •Rate alarm upper limit value •Rate alarm lower limit value •Scaling range lower limit value •Scaling range upper limit value •Scaling valid/invalid setting •Scaling width lower limit value •Scaling width upper limit value •Conversion setting for disconnection detection •Conversion setting value for disconnection detection 	Section 5.4
	(2) The initial setting data are registered in the parameter of the programmable controller CPU and automatically written to the Q68RD3-G when the programmable controller CPU changes to the RUN status.	
Auto refresh setting	(1) Sets the automatically refreshed Q68RD3-G buffer memory for each channel. <ul style="list-style-type: none"> •Conversion completion flag •CH□ Measured temperature value •Error code •Setting range (Input type CH1-CH4) •Setting range (Input type CH5-CH8) •Setting range (Offset/gain setting CH1-CH8) •Warning output flag (Process alarm) •Warning output flag (Rate alarm) •Disconnection detection flag •CH□ Scaling value 	Section 5.5
	(2) The values stored in the Q68RD3-G buffer memory where auto refresh setting has been made are automatically read from/written to the device when the END instruction of the programmable controller CPU is executed.	

Table 5.1 List of utility package (GX Configurator-TI) functions (2/2)

Function	Description	Reference	
Monitor/test	Monitors and tests the buffer memory and I/O signals of the Q68RD3-G.	Section 5.6	
	<ul style="list-style-type: none"> •Module ready •Operating condition setting completion flag •Operating condition setting request •Offset/gain setting mode status flag •User range write request •Channel change completion flag 		<ul style="list-style-type: none"> •Disconnection detection signal •Warning output signal •Conversion completion flag •Error flag •Error clear request •Mode switching setting
	(1) CH□ Monitor/test		
	<ul style="list-style-type: none"> •Conversion enable/disable setting •Averaging processing selection •Time/Count/Moving average/Time constant setting •Conversion completion flag •Measured temperature value •Error code •Setting range •Process alarm warning output enable/disable setting •Warning output flag (Process alarm) lower limit value •Warning output flag (Process alarm) upper limit value •Process alarm lower lower limit value •Process alarm lower upper limit value •Process alarm upper lower limit value •Process alarm upper upper limit value 		<ul style="list-style-type: none"> •Rate alarm warning output enable/disable setting •Rate alarm warning detection period •Warning output flag (Rate alarm) lower limit value •Warning output flag (Rate alarm) upper limit value •Rate alarm upper limit value •Rate alarm lower limit value •Disconnection detection flag •Scaling value •Scaling valid/invalid setting •Scaling range lower limit value •Scaling range upper limit value •Scaling width lower limit value •Scaling width upper limit value •Conversion setting for disconnection detection •Conversion setting value for disconnection detection
	(2) Offset/gain setting		
	<ul style="list-style-type: none"> •Mode switching setting •Mode switching setting status •Conversion enable/disable setting •Operating condition setting request •Setting range •CH□ Offset setting channel setting 		<ul style="list-style-type: none"> •CH□ Offset setting value •CH□ Gain setting channel setting •CH□ Gain setting value •Channel change completion flag •Channel change request •CH□ Measured temperature value
	(3) X/Y Monitor/test		
	<ul style="list-style-type: none"> •Xn0: Module ready •Xn9: Operating condition setting completion flag •XnA: Offset/gain setting mode status flag •XnB: Channel change completion flag •XnC: Disconnection detection signal •XnD: Warning output signal •XnE: Conversion completion flag •XnF: Error flag 		<ul style="list-style-type: none"> •Yn9: Operating condition setting request •YnA: User range write request •YnB: Channel change request •YnF: Error clear request
	(4) OMC (Online Module Change) refresh data		
	<ul style="list-style-type: none"> •CH□ Factory default offset/gain values •CH□ User range settings resistance offset/gain values •OMC (Online Module Change) refresh data write request 		<ul style="list-style-type: none"> •CH□ User range settings offset/gain values •OMC (Online Module Change) refresh data read request

5.2 Installing and Uninstalling Utility Package

For installation and uninstallation of a utility package, refer to the "Method of installing the MELSOFT Series" provided with the utility package.

5.2.1 Precautions for use

This section describes the precautions for using GX Configurator-TI.

(1) Safety

Since GX Configurator-TI is add-in software for GX Developer, read "Safety Precautions" and the basic operating procedures in the GX Developer Operating Manual.

(2) Installation

GX Configurator-TI shall be added in GX Developer Version 4 or later. Therefore, it must be installed on the personal computer that has already been GX Developer Version 4 or later installed.

(3) Screen display error when intelligent function module utility is used

Insufficient system resource may cause inappropriate display of the screen when the intelligent function module utility is used. If this occurs, close the intelligent function module utility first, and subsequently GX Developer (such as programs and comments) and other applications. Then, restart GX Developer and the intelligent function module utility.

(4) Activating intelligent function module utility

(a) PLC series set in GX Developer

A project must be specified. When creating a new project, select "QCPU (Q mode)" for the PLC series in GX Developer.

If any series other than "QCPU (Q mode)" is selected, or if no project is specified, the intelligent function module utility cannot be activated.

(b) Activation of multiple utilities

Multiple intelligent function module utilities can be activated.

Note, however, that "Open parameters" and "Save parameters" operations under "Intelligent function module parameter" are allowed for one intelligent function module utility only.

For the other utilities, only the "Monitor/test" operation is allowed.

(5) Switching screens between two or more intelligent function module utilities

When two or more intelligent function module utility screens cannot be displayed side by side, select a screen to be displayed on the top of others using the task bar.



(6) Number of parameters that can be set in GX Configurator-TI

When multiple intelligent function modules are mounted, the number of parameter settings must not exceed the following limit.

Table 5.2 Maximum number of parameter settings

When intelligent function modules are installed to:	Maximum number of parameter settings	
	Initial setting	Auto refresh setting
Q00J/Q00/Q01CPU	512	256
Q02/Q02H/Q06H/Q12H/Q25HCPU	512	256
Q02PH/Q06PH/Q12PH/Q25PHCPU	512	256
Q12PRH/Q25PRHCPU	512	256
Q00UJ/Q00U/Q01UCPU	512	256
Q02UCPU	2048	1024
Q03UD/Q04UDH/Q06UDH/ Q10UDH/Q13UDH/Q20UDH/ Q26UDH/Q03UDE/Q04UDEH/ Q06UDEH/Q10UDEH/Q13UDEH/ Q20UDEH/Q26UDEHCPU	4096	2048
CPU modules other than the above	Not available	Not available
MELSECNET/H remote I/O station	512	256

For example, if multiple intelligent function modules are mounted to the MELSECNET/H remote I/O station, make the settings in GX Configurator-TI so that the total number of parameter settings set for all the intelligent function modules does not exceed the maximum number of parameter settings of the MELSECNET/H remote I/O station. Calculate the total number of parameter settings for initial setting and auto refresh setting, respectively.

The following table shows the number of parameter settings that can be set for one module in GX Configurator-TI.

Table 5.3 Number of parameter settings that can be set for one module

Target module	Initial setting	Auto refresh setting
Q68RD3-G	6 (Fixed)	24 (Max.)

Example) Counting the number of parameter settings for the auto refresh setting

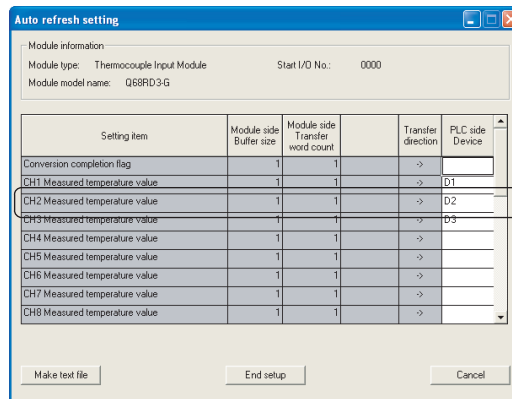

← This one row is counted as one setting. Blank rows are not counted. Count up all the setting items on this screen, and add the total to the number of settings for other intelligent function modules to get a grand total.

5.2.2 Operating environment

This section describes the operating environment of the personal computer that runs GX Configurator-TI.

Table 5.4 Operating environment of personal computer

Item	Description
Installation (Add-in) target* ¹	GX Developer Version 4 (English version) or later * ² * ⁴
Computer	A personal computer with any of the operating systems below
CPU	Refer to the next page "Operating system and performance required for personal computer".
Required memory	
Hard disk space	For installation: 65MB or more
	For operation: 10MB or more
Display	800 × 600 dots or more resolution* ³
Operating system	Microsoft® Windows® 95 Operating System (English version) Microsoft® Windows® 98 Operating System (English version) Microsoft® Windows® Millennium Edition Operating System (English version) Microsoft® Windows NT® Workstation Operating System Version 4.0 (English version) Microsoft® Windows® 2000 Professional Operating System (English version) Microsoft® Windows® XP Professional Operating System (English version) Microsoft® Windows® XP Home Edition Operating System (English version) Microsoft® Windows Vista® Home Basic Operating System (English version) Microsoft® Windows Vista® Home Premium Operating System (English version) Microsoft® Windows Vista® Business Operating System (English version) Microsoft® Windows Vista® Ultimate Operating System (English version) Microsoft® Windows Vista® Enterprise Operating System (English version) Microsoft® Windows® 7 Starter Operating System (English version)* ⁴ Microsoft® Windows® 7 Home Premium Operating System (English version)* ⁴ Microsoft® Windows® 7 Professional Operating System (English version)* ⁴ Microsoft® Windows® 7 Ultimate Operating System (English version)* ⁴ Microsoft® Windows® 7 Enterprise Operating System (English version)* ⁴

- * 1 Install GX Configurator-TI in GX Developer Version 4 or later in the same language. GX Developer (English version) and GX Configurator-TI (Japanese version) cannot be used in combination, and GX Developer (Japanese version) and GX Configurator-TI (English version) cannot be used in combination.
- * 2 GX Configurator-TI can not be installed in GX Developer Version 3 or earlier.
- * 3 When Windows Vista® or Windows® 7 is used, resolution of 1024 × 768 dots or more is recommended.
- * 4 When 32-bit Windows® 7 is used, add GX Configurator-TI Version 1.28AE or later in GX Developer Version 8.91V or later.
When 64-bit Windows® 7 is used, add GX Configurator-TI Version 1.28AE or later in GX Developer Version 8.98C or later.

Table 5.5 Operating system and performance required for personal computer

Operating system	Performance required for personal computer	
	CPU	Required memory
Windows® 95	Pentium® 133MHz or more	32MB or more
Windows® 98	Pentium® 133MHz or more	32MB or more
Windows® Me	Pentium® 150MHz or more	32MB or more
Windows NT® Workstation 4.0	Pentium® 133MHz or more	32MB or more
Windows® 2000 Professional	Pentium® 133MHz or more	64MB or more
Windows® XP	Pentium® 300MHz or more	128MB or more
Windows Vista®	Pentium® 1GHz or more	1GB or more
Windows® 7	Pentium® 1GHz or more	1GB or more (32-bit) 2GB or more (64-bit)

POINT

(1) The functions shown below are not available for Windows® XP, Windows Vista®, and Windows® 7. If any of the following functions is attempted, this product may not operate normally.

- Start of application in Windows® compatible mode
- Fast user switching
- Remote desktop
- Large fonts (Details setting of Display Properties)
- DPI setting other than 100%
- 64-bit version *1
- Windows XP Mode
- Windows Touch

* 1 It is available for Windows® 7.

(2) A user with USER authority or higher can access GX Configurator-TI for Windows Vista®.

5.3 Operating Utility Package

5.3.1 Common operations

(1) Control keys

The following table shows the special keys that can be used for operating the utility package and their applications.

Table 5.6 Available control keys

Key	Application
Esc	<p>Cancels the current entry in a cell.</p> <p>Closes the window.</p>
Tab	Moves between controls in the window.
Ctrl	Used in combination with the mouse operation to select multiple cells for test execution.
Delete	<p>Deletes the character where the cursor is positioned.</p> <p>When a cell is selected, clears all of the setting contents in the cell.</p>
Back Space	Deletes the character where the cursor is positioned.
↑ ↓ ← →	Moves the cursor.
Page Up	Moves the cursor one page up.
Page Down	Moves the cursor one page down.
Enter	Completes the entry in the cell.

(2) Data created with utility package

The following data or files that are created with utility package can be also handled in GX Developer. Figure 5.1 shows respective data or files are handled in which operation.

<Intelligent function module parameters>

- (a) This represents the data created in Auto refresh setting, and they are stored in an intelligent function module parameter file in a project created by GX Developer.

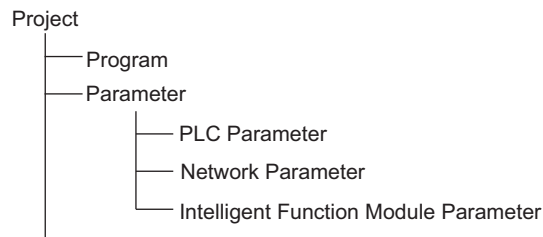

<Text File>

A text file is a file created by clicking the **Make text file** button on the "Initial setting" screen, "Auto refresh setting" screen or "Monitor/test" screen. Text files can be utilized to create user documents.

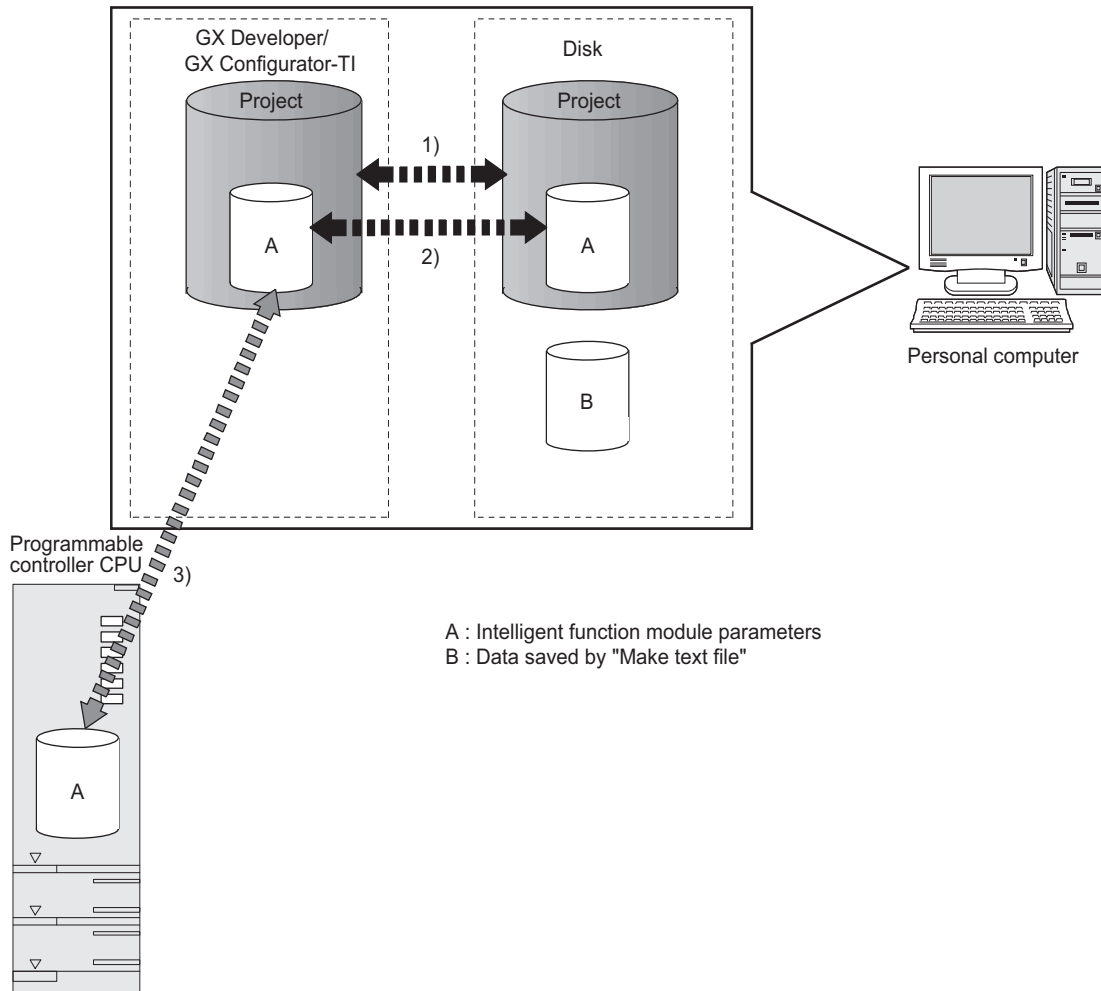

Figure 5.1 Flow of data created with utility package

Steps 1) to 3) shown in Figure 6.1 are performed as follows:

- 1) From GX Developer, select:
[Project] → [Open project] / [Save] / [Save as]
- 2) On the intelligent function module selection screen of the utility, select:
[Intelligent function module parameter] → [Open parameters] / [Save parameters]
- 3) From GX Developer, select:
[Online] → [Read from PLC] / [Write to PLC] → "Intelligent function module parameters"
Alternatively, from the intelligent function module selection screen of the utility, select:
[Online] → [Read from PLC] / [Write to PLC]

5.3.2 Operation overview

GX Developer screen

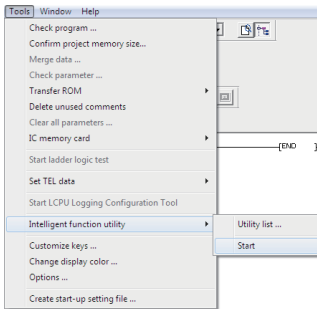

↓ [Tools] - [Intelligent function utility] - [Start]

Screen for selecting a target intelligent function module

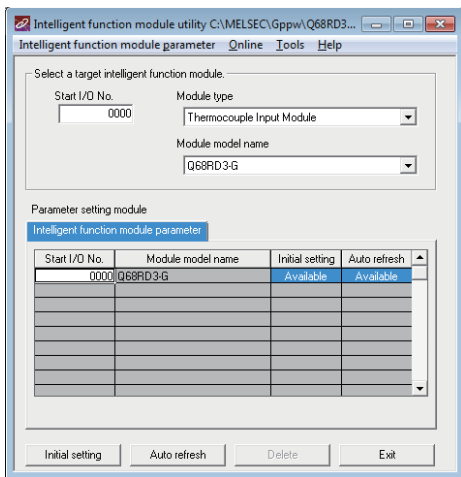

Refer to Section 5.3.3.

Enter "Start I/O No.", and select "Module type" and "Module model name".

Initial setting

Auto refresh

Initial setting screen

Auto refresh setting screen

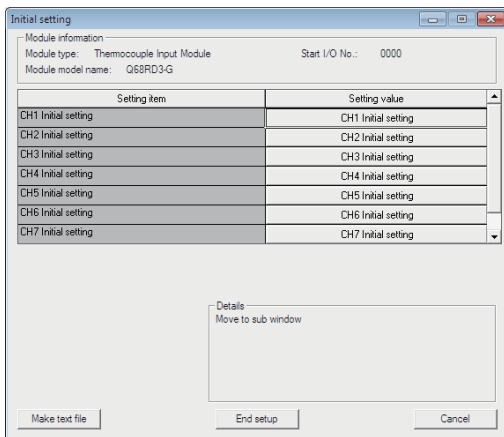

Refer to Section 5.4.

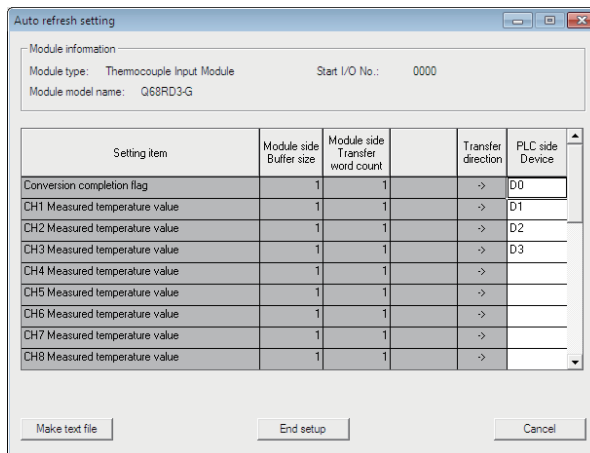

Refer to Section 5.5.

1) [Online] - [Monitor/Test]

Select monitor/test module screen

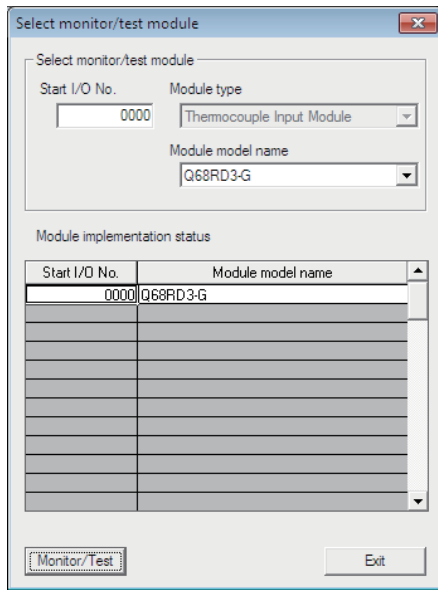

Select a module to be monitored/tested.

Monitor/Test screen

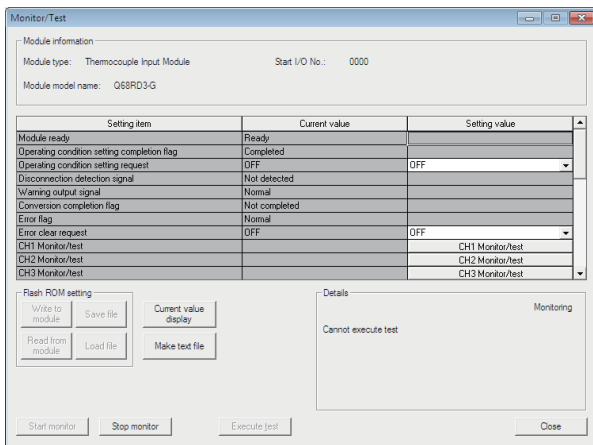

Refer to Section 5.6.

5.3.3 Activating intelligent function module utility

[Procedure]

Intelligent function module utility is started from GX Developer.

[Tools] → [Intelligent function utility] → [Start]

[Setting screen]

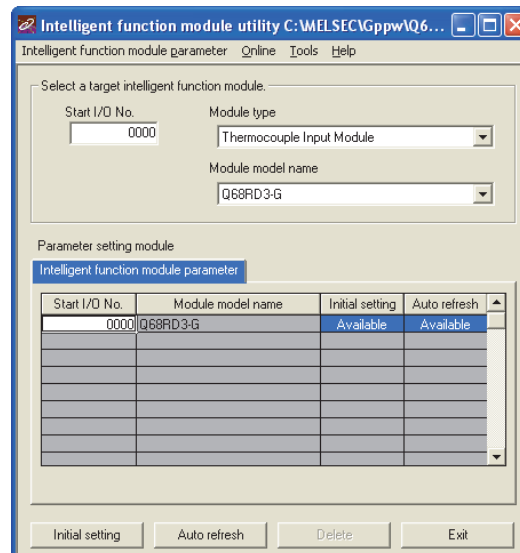

[Description of screen items]

(1) Activation of screens

Following screens can be displayed from the intelligent function module utility screen.

(a) "Initial setting" screen

"Start I/O No.*1" → "Module type" → "Module model name" → 

(b) "Auto refresh setting" screen

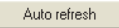
"Start I/O No.*1" → "Module type" → "Module model name" → 

(c) "Select monitor/test module" screen

[Online] → [Monitor/test]

* 1 Enter the start I/O No. in hexadecimal.

(2) Command buttons

 Deletes the initial setting or auto refresh setting of the selected module.

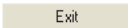
 Closes this screen.

(3) Menu bar

- (a) Menu options under [Intelligent function module parameter]
Intelligent function module parameters of the project opened by GX Developer are targeted.

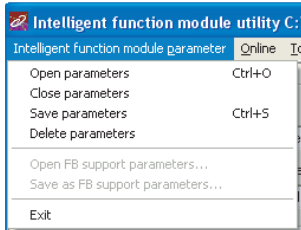

- [Open parameters] : Reads a parameter file.
- [Close parameters] : Closes a parameter file. If data are modified, a dialog box asking for saving data will appear.
- [Save parameters] : Saves a parameter file.
- [Delete parameters] : Deletes a parameter file.
- [Open FB support parameters] : Opens a FB support parameter file.
- [Save as FB support parameters] : Saves a FB support parameter file.
- [Exit] : Closes this screen.

- (b) Menu options under [Online]

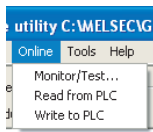

- [Monitor/Test] : Activates the "Select monitor/test module" screen.
- [Read from PLC] : Reads the intelligent function module parameters from the CPU module.
- [Write to PLC] : Writes the intelligent function module parameters to the CPU module.

POINT

- (1) Saving intelligent function module parameters
Intelligent function module parameters cannot be saved by the project saving operation of GX Developer. Save them using the menu option described above on the screen for selecting a target intelligent function module.
- (2) Reading/writing intelligent function module parameters from/to a programmable controller CPU using GX Developer
 - The Read from PLC/Write to PLC operations are enabled after intelligent function module parameters have been saved.
 - Set a target programmable controller CPU on the screen displayed by selecting [Online] → [Transfer setup] in GX Developer.
 - When the Q68RD3-G is mounted to a remote I/O station, use the Read from PLC/Write to PLC functions of GX Developer.
- (3) Checking the required utility
There may be a case where the start I/O No. is displayed correctly, but the module model name is displayed as "" on the intelligent function module utility setting screen.
In this case, the required utility has not been installed or the utility cannot be started from GX Developer.
Check the required utility by selecting [Tools] - [Intelligent function utility] - [Utility list...] in GX Developer.

5.4 Initial Setting

[Purpose]

Makes initial settings, which are required to operate the Q68RD3-G, for each channel. For the initial setting parameter items, refer to Section 5.1. Setting parameters in the Initial setting screen can omit parameter settings in sequence programs.

[Procedure]

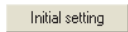
"Start I/O No.*1" → "Module type" → "Module model name" → 

* 1 Enter the start I/O No. in hexadecimal.

[Setting screen]

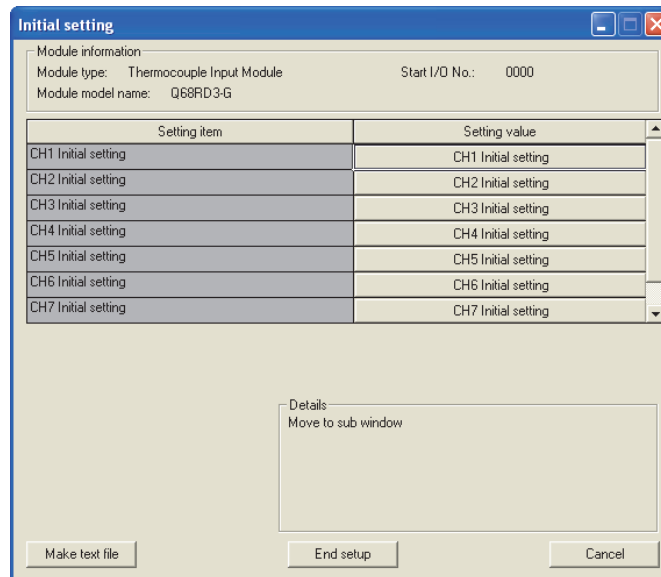



[Description of screen items]

(1) Setting details

Set the temperature conversion enable/disable and the temperature conversion system for each channel.

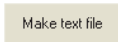
(2) Command buttons

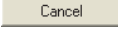
	Creates a file containing the screen data in a text file format.
	Saves the setting data and ends the operation.
	Cancels the setting data and ends the operation.

☒ POINT

Initial setting data are stored in intelligent function module parameters. After being written to the CPU module, the initial setting data are made effective by operating either (1) or (2).

- (1) Change the RUN/STOP switch of the CPU module: STOP → RUN → STOP → RUN.
- (2) After setting the RUN/STOP switch to RUN, power the programmable controller OFF → ON or reset the CPU module.

When using a sequence program to write initial setting data, the data will be written when the CPU module is switched from STOP to RUN. Create a program so that initial setting is re-executed in the sequence program.

5.5 Auto Refresh Setting

[Purpose]

Sets the automatically refreshed Q68RD3-G buffer memory for each channel.

[Procedure]

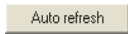
"Start I/O No.*1" → "Module type" → "Module model name" → 

* 1 Enter the start I/O No. in hexadecimal.

[Setting screen]

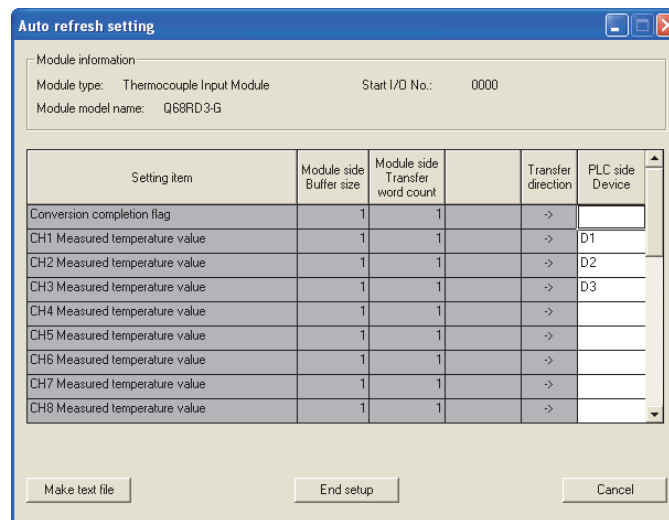



Setting item	Module side Buffer size	Module side Transfer word count	Transfer direction	PLC side Device
Conversion completion flag	1	1	->	
CH1 Measured temperature value	1	1	->	D1
CH2 Measured temperature value	1	1	->	D2
CH3 Measured temperature value	1	1	->	D3
CH4 Measured temperature value	1	1	->	
CH5 Measured temperature value	1	1	->	
CH6 Measured temperature value	1	1	->	
CH7 Measured temperature value	1	1	->	
CH8 Measured temperature value	1	1	->	

[Description of screen items]

(1) Screen items

- Model side Buffer size** : Displays the transferable buffer memory size of the setting item (fixed to one word).
- Model side Transfer word count** : Displays the number of transferable words starting from the "PLC side Device" (fixed to one word).
- Transfer direction** : "←" indicates that data are written from the device to the buffer memory.
"→" indicates that data are read from the buffer memory to the device.
- PLC side Device** : Enter a device of the CPU module that is automatically refreshed.
Applicable devices are X, Y, M, L, B, T, C, ST, D, W, R, and ZR.
When using bit devices X, Y, M, L or B, set a device number that can be divided by 16 points (examples: X10, Y120 or M16).
Buffer memory data are stored in a 16-point area, starting from the specified device number.
For example, if X10 is entered, data are stored in X10 to X1F.

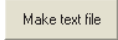
(2) Command buttons

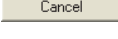
	Creates a file containing the screen data in a text file format.
	Saves the setting data and ends the operation.
	Cancels the setting data and ends the operation.

POINT

Auto refresh setting data are stored in intelligent function module parameters. After being written to the CPU module, the auto refresh setting data are made effective by operating either (1) or (2).

- (1) Change the RUN/STOP switch of the CPU module: STOP → RUN → STOP → RUN.
- (2) After setting the RUN/STOP switch to RUN, power the programmable controller OFF → ON or reset the CPU module.

The auto refresh settings cannot be changed from sequence programs. However, processing equivalent to auto refresh setting can be added using the FROM/TO instructions in the sequence program.

5.6 Monitor/Test

5.6.1 Monitor/test screen

[Purpose]

Activates screens for monitoring/testing buffer memory and I/O signals, performing offset/gain setting (refer to Section 5.6.2), and saving/restoring user range (refer to Section 5.6.3).

[Procedure]

On the "Select monitor/test module" screen, "Start I/O No.*1" → "Module type" → "Module model name" → **Monitor/Test**

* 1 Enter the start I/O No. in hexadecimal.

The screen can also be activated from System monitor of GX Developer Version 6 or later.

For details, refer to the GX Developer Operating Manual.

[Setting screen]

The main **Monitor/Test** screen displays the following table of setting items:

Setting item	Current value	Setting value
Error clear request	OFF	OFF
CH1 Monitor/test		CH1 Monitor/test
CH2 Monitor/test		CH2 Monitor/test
CH3 Monitor/test		CH3 Monitor/test
CH4 Monitor/test		CH4 Monitor/test
CH5 Monitor/test		CH5 Monitor/test
CH6 Monitor/test		CH6 Monitor/test
CH7 Monitor/test		CH7 Monitor/test
CH8 Monitor/test		CH8 Monitor/test
XY Monitor/test		XY Monitor/test
DMC (Online Module Change) refresh data		DMC refresh data

Clicking on **CH1 Monitor/test** leads to the **CH1 Monitor/test** screen, which includes settings for conversion enable/disable, averaging processing, and temperature measurement.

Clicking on **CH1 Offset/gain setting** leads to the **CH1 Offset/gain setting** screen, which includes instructions for activating offset/gain setting mode and mode switching settings.

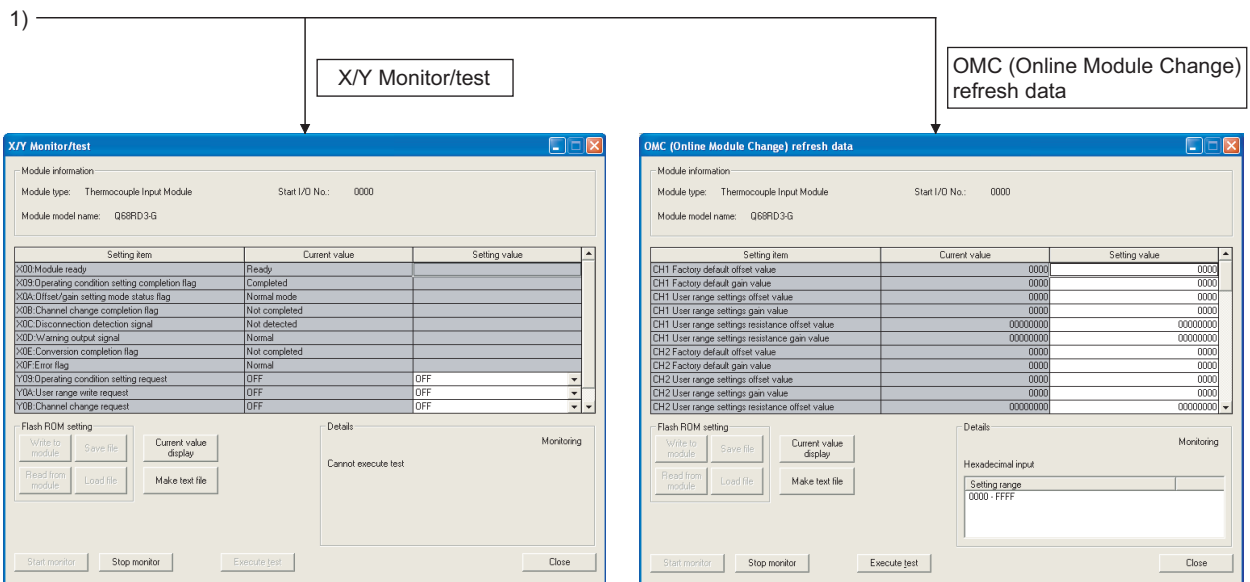

[Description of screen items]

(1) Screen items

Setting item :Displays I/O signals and buffer memory names.

Current value :Monitors I/O signal status and current buffer memory value.

Setting value :Enter or select the data to be written into the buffer memory by test operation.

(2) Command buttons

Current value display

Displays the current value of the selected item. (This button is used to check the text that cannot be displayed in the current value field. However, in this utility package, all items can be displayed in the display fields).

Make text file

Creates a file containing the screen data in a text file format.

Start monitor / Stop monitor

Selects whether or not to monitor current values.

Execute test

Executes a test on the selected item. To select more than one item, select them while holding down the Ctrl key.

Close

Closes the open screen and returns to the previous screen.

(3) Example of using "Execute test"

The following is an example to change sampling processing of CH1 to count averaging processing in 10 times.

(a) Click the "CH1 Monitor/test" button in the "Monitor/Test" screen.

(b) Select "Count" for "Averaging processing selection".

(c) Click the setting area for "Time/Count/Moving average/Time constant setting".

(d) Input "10" as the number of averaging, then click the Enter key.
At this point, this setting is not written to the Q68RD3-G.

(e) Select the setting areas (b) to (d), holding the Ctrl key.
Multiple items can be selected by dragging the mouse over them also.

(f) Click Execute test to write the data.

After the writing is completed, the written values are displayed in the "Current value" field.

At this point, the module is operating in the setting before the change made in (b) to (d).

(g) Set "Operating condition setting request" to "Request".

(h) Activate the set data by clicking Execute test, while the setting area for "Operating condition setting request" is selected.

5.6.2 Offset/gain setting operation

Perform the offset/gain setting operation in the following sequence.

(1) Displaying the "CH□ Offset/gain setting" screen



Display the "CH□ Offset/gain setting" screen of the setting target channel, referring to the operation described in Section 5.6.1.

(2) Switching to the offset/gain setting mode

Note) Do not perform this operation when the setting has already been in the offset/gain setting mode.

Set "Offset/gain setting mode" in the Setting value field of "Mode switching setting" and click the  button. "Offset/gain setting mode" will be set in the Current value field of "Mode switching setting status".

(3) Enabling the conversion enable/disable setting

- (a) Set "Enable" in the Setting value field of "Conversion enable/disable setting" and click the  button.
- (b) Set "Request" in the Setting value field of "Operating condition setting request" and click the  button. "Request" will be set in the Current value field.
- (c) Set "OFF" in the Setting value field of "Operating condition setting request" and click the  button. "OFF" will be set in the Current value field.

(4) Adjusting offset/gain values

(a) Adjusting offset values

1) Selecting "Offset setting"

Select "Offset setting" in the Setting value field of "CH□ Offset setting channel setting" and click the  button.

2) Setting an offset value

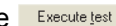
Enter a desired value in the Setting value field of "CH□ Offset temperature setting value" and click the  button.

3) Determining the offset value

Select "Request" in the Setting value field of "CH□ Channel change request" and click the  button.

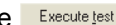
Confirm that "CH□ Channel change completion flag" has changed to "Completed", and then select "OFF" in the Setting value field of "CH□ Channel change request" and click the  button.

Select "Invalid" in the Setting value field of "CH□ Offset setting channel setting" and click the  button.

(b) Adjusting gain values

1) Selecting "Gain setting"

Set "Gain setting" in the Setting value field of "CH□ Gain setting channel setting" and click the  button.

2) Setting a gain value

Enter a desired value into the Setting value field of "CH□ Gain setting value" and click the  button.

3) Determining the gain value

Select "Request" in the Setting value field of "CH□ Channel change request" setting and click the  button.

Confirm that "CH□ Channel change completion flag" has changed to "Completed", and then select "OFF" in the Setting value field of "CH□ Channel change request" and click the  button.

Select "Invalid" in the Setting value field of "CH□ Gain setting channel setting" and click the  button.

- (c) To set offset/gain values for more than one channel, repeat steps (a) 1) to 3) and (b) 1) to 3).

(5) Returning to the "Monitor/test" screen

Referring to the operation described in Section 5.6.1, close the "CH□ Offset/gain setting" screen and return to the "Monitor/test" screen.

(6) Writing the offset/gain setting values to the module

Write the offset/gain setting values to the module after the settings for all channels using the user range setting have been completed. Note that if the values are written before offset/gain setting has been completed, the status at that point will be written to the module.

(a) How to write the values

1) Write to the Q68RD3-G

Select "Request" for "User range write request", and click .

2) Confirm the executing of writing

Confirm that the Current value field of "Offset/gain setting mode status flag" shifts from "Offset/gain setting mode" to "Normal mode".

3) Finish writing

Select "OFF" for "User range write request", and click .

POINT

While the set data of the steps (a)1) to (a)2) above are written to the module, do not perform the operations below. If they are performed, the data inside a flash memory will have a problem, and the Q68RD3-G may not operate normally.

- Powering off the programmable controller CPU
- Resetting the programmable controller CPU

(b) Corrective action at error occurrence

Confirm that the "ERR." LED of the Q68RD3-G is off. If the "ERR." LED turns on, click the  button, check the error code on the monitor screen, and then perform offset/gain setting again.

(7) Switch to the normal mode

Set "Normal mode" in the Setting value field of "Mode switching setting" and click the

 button to execute data writing.

Upon completion of writing data, the display in the Current value field of "Mode switching setting" changes to "Normal mode".

5.6.3 OMC (Online Module Change) refresh data

Perform the user range save/restore operations in the following sequence.

(1) Display OMC (Online Module Change) refresh data screen

Display the "OMC (Online Module Change) refresh data" screen, referring to the operation described in Section 5.6.1.

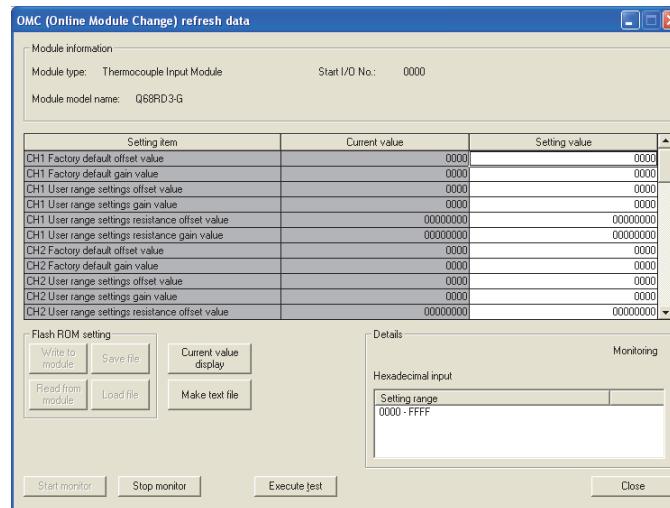

(2) Saving user range

(a) Set "Request" in the Setting value field of "OMC (Online Module Change) refresh data read request" and click the button.

Upon completion of reading data, the values are displayed in the Current value fields of "CH□ Factory default offset/gain value", "CH□ User range settings offset/gain value", and "CH□ User range settings resistance offset/gain value".

(b) Compare the values with those in the range reference table. If values are appropriate, take them down.

For the range reference table, refer to Section 7.4.

(3) Restoring user range

(a) Set the noted values in the Setting value fields of "CH□ Factory default offset/gain value", "CH□ User range settings offset/gain value", and "CH□ User range settings resistance offset/gain value".

(b) Select all the Setting value fields of "CH□ Factory default offset/gain value", "CH□ User range settings offset/gain value", and "CH□ User range settings resistance offset/gain value", and click the button.

Upon completion of writing data, the set values are displayed in the Current value fields of the corresponding items.

(c) Set "Request" in the Setting value field of "OMC (Online Module Change) refresh data write request" and click the button.

Confirm that the Current value field of the same item changes from "Request" to "OFF" upon completion of writing data.

CHAPTER6 PROGRAMMING

This chapter describes programs of the Q68RD3-G.

When applying any of the program examples introduced in this chapter to the actual system, make sure to examine the applicability and confirm that no problems will occur in the system control.

1

OVERVIEW

2

SYSTEM
CONFIGURATION

3

SPECIFICATIONS

4

PROCEDURES AND
SETTINGS BEFORE
SYSTEM OPERATION

5

UTILITY PACKAGE
(GX CONFIGURATOR-TI)

6

PROGRAMMING

7

ONLINE MODULE
CHANGE

8

TROUBLESHOOTING

6.1 Programming Procedure

Create a program that executes temperature input of the Q68RD3-G in the following procedure.

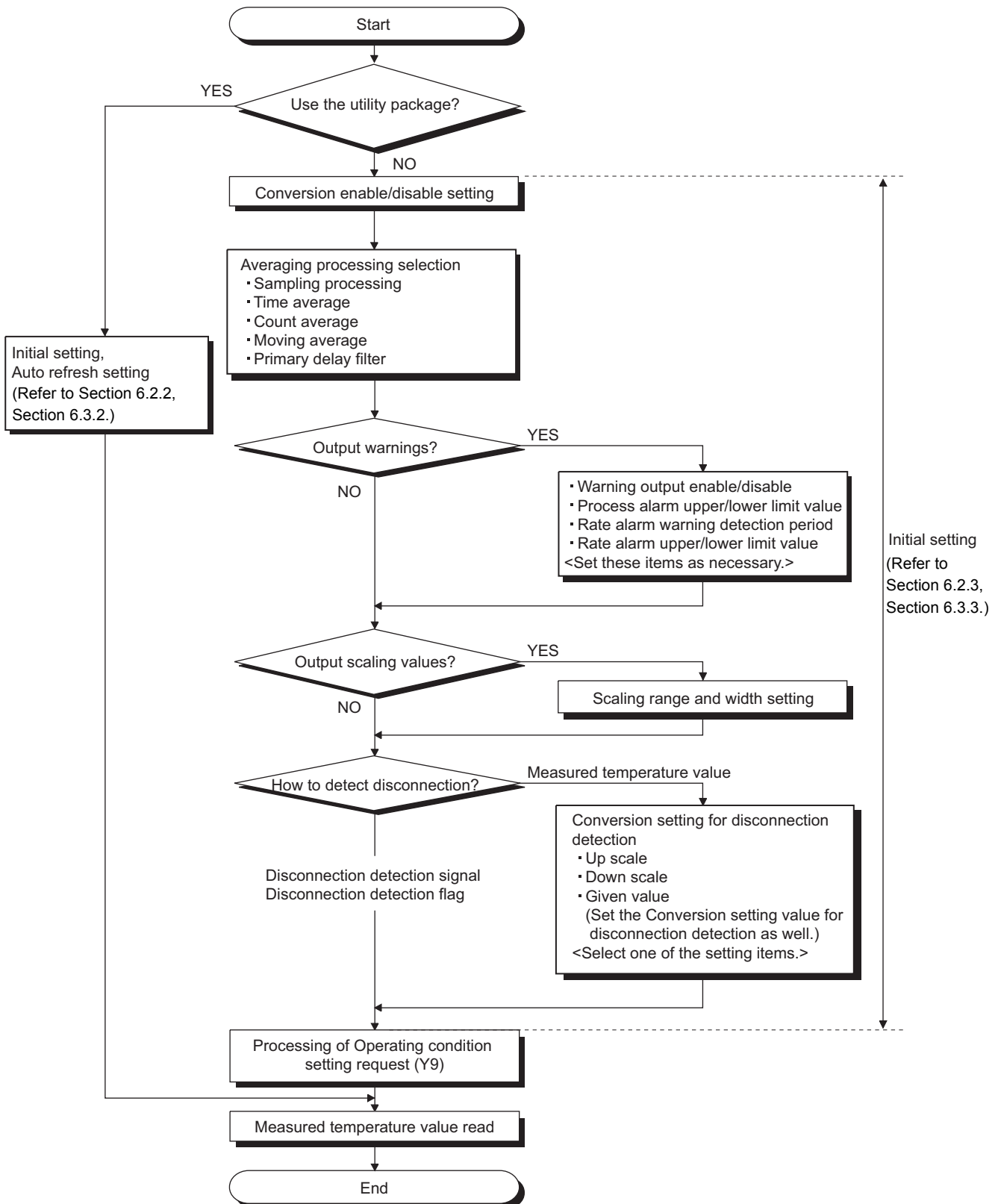

(1) Program example outline

Program examples include following processing.

- (a) Initial setting program of the Q68RD3-G
- (b) Measured temperature value read
- (c) Processing at CH1 disconnection detection
- (d) Processing when CH2 process alarm is used
- (e) Processing when CH3 rate alarm is used
- (f) Error code output to an output module in BCD

6.2 Using Programs in Normal System Configuration

This section describes program examples based on the following system configuration and conditions.

(1) System configuration

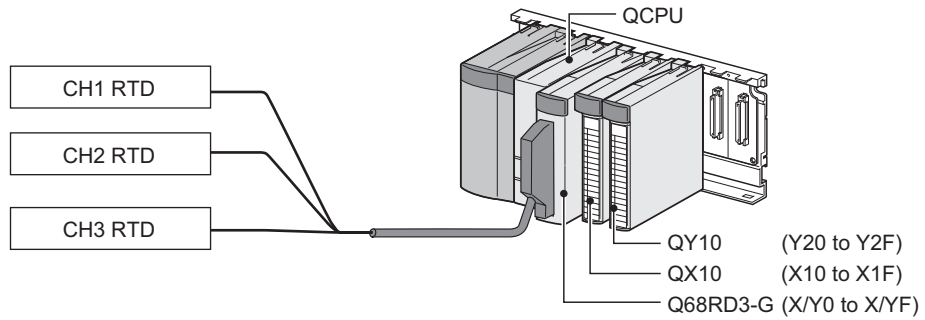

(2) Setting conditions for the intelligent function module switch setting

Table 6.1 Setting conditions for the intelligent function module switch setting

Channel	RTD (Measurement range)	Offset/gain setting
CH1	Pt100 (-200°C to 850°C)	Factory default setting
CH2		
CH3		
CH4 to CH8	Not used	—

(3) Programming conditions

- (a) Use the following temperature conversion system for each channel.
- CH1: Sampling processing
 - CH2: Count average (5 times)
 - CH3: Primary delay filter (Time constant 960ms)
- (b) Use the following function at each channel.
- CH2: Warning output function
 - Process alarm lower lower limit value: 2000 (200°C),
 - Process alarm lower upper limit value: 2050 (205°C),
 - Process alarm upper lower limit value: 2950 (295°C),
 - Process alarm upper upper limit value: 3000 (300°C)
 - CH3: Warning output function
 - Rate alarm warning detection period: 3 times (960ms),
 - Rate alarm lower limit value: -50 (-5.0°C),
 - Rate alarm upper limit value: 50 (+5.0°C)
- (c) Use the following setting for the Conversion setting for disconnection detection of CH1 to CH3.
- CH1 to CH3: Down scale (-252.5°C) [Default setting]
- (d) When a write error occurs, the corresponding error code is output to an output module in BCD value.
- (e) Perform the disconnection detection reset operation after the connection is re-established.

6.2.1 Before creating a program

This section describes the steps to be taken before creating a program.

(1) Wiring of external devices

Mount the Q68RD3-G onto the base unit and connect RTD (Pt100) to CH1 to CH3.
For details, refer to Section 4.4.2.

[Wiring diagram]

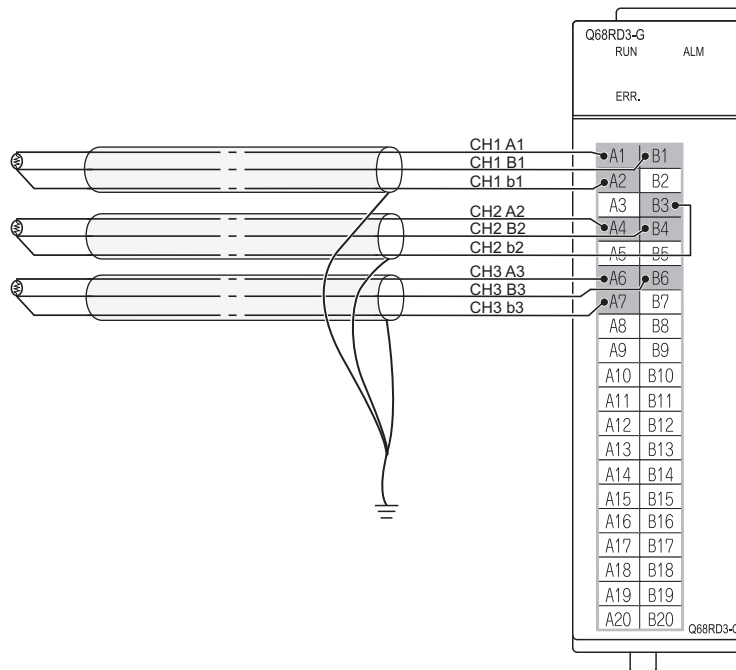

(2) Intelligent function module switch setting

Based on the setting conditions given in Section 6.2 (2), make the intelligent function module switch setting.

(a) Setting details of each switch

1) Switch 1, Switch 2: Measurement range setting

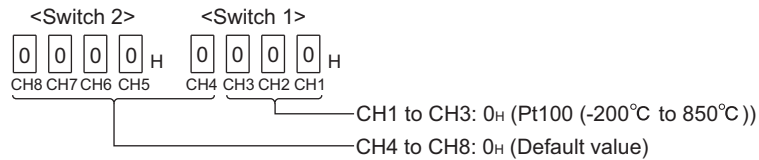

2) Switch 3 : Offset/gain setting

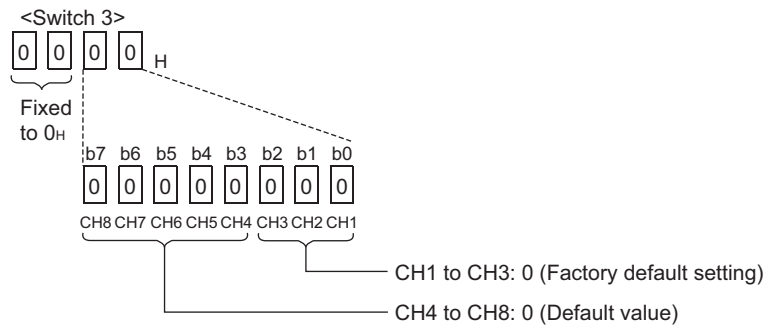

3) Switch 4: Mode setting

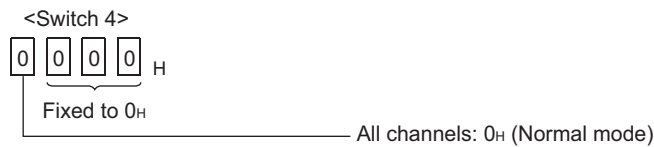

4) Switch 5: Use prohibited (Fixed to 0H. *1)

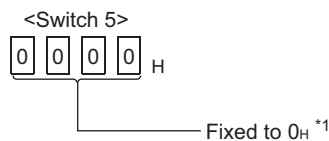

* 1 If any value other than 0H is set, an error occurs.

(b) Intelligent function module switch setting

Click the **Switch setting** button on the "I/O assignment" tab of PLC parameter in GX Developer to display the following screen, and make settings for switch 1 to 5.

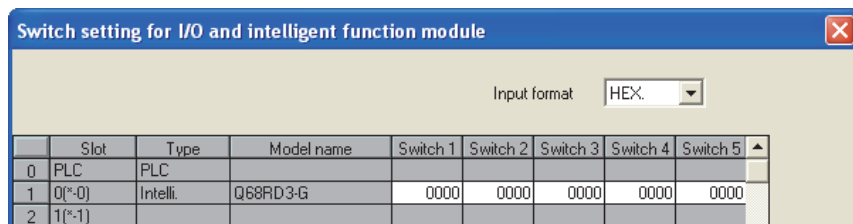

6.2.2 Program example when utility package is used

(1) List of devices

Table 6.2 List of devices

Device	Function	
D0	Device that Conversion completion flag is written by auto refresh	
D1	Device that CH1 Measured temperature value is written by auto refresh	
D2	Device that CH2 Measured temperature value is written by auto refresh	
D3	Device that CH3 Measured temperature value is written by auto refresh	
D4	Device that Error code is written by auto refresh	
D5	Device that Warning output flag (Process alarm) is written by auto refresh	
D6	Device that Warning output flag (Rate alarm) is written by auto refresh	
D7	Device that Disconnection detection flag is written by auto refresh	
D11	CH1 Measured temperature value	
D12	CH2 Measured temperature value	
D13	CH3 Measured temperature value	
X0	Module ready	Q68RD3-G (X/Y0 to X/YF)
XC	Disconnection detection signal	
XF	Error flag	
YF	Error clear request	
X10	Device that user turns ON to start reading measured temperature values	QX10 (X10 to X1F)
X11	Device that user turns ON to reset a disconnection detection state	
X12	Device that user turns ON to reset an error	
Y20 to Y2B	Error code display (BCD 3 digits)	QY10 (Y20 to Y2F)

(2) Utility package operation

(a) Initial setting (Refer to Section 5.4.)

Set the items shaded in the table below to CH1 to CH3.

Setting for the items with "—" is not required when "Disable", "Invalid" or "Down scale" has been selected.

(Default value, which will be displayed in the Setting value field, does not need to be changed.)

Table 6.3 List of initial setting items

Setting item	Default	CH1	CH2	CH3
Conversion enable/disable setting	Disable	Enable	Enable	Enable
Averaging processing selection	Sampling	Sampling	Count	Primary delay filter
Time/Count/Moving average/ Time constant setting	0	0	5	960
Process alarm warning output enable/disable setting	Disable	Disable	Enable	Disable
Setting range	New JIS (-200 to 850°C)	Setting not required (Default value)	New JIS (-200 to 850°C)* ¹	Setting not required (Default value)
Process alarm lower lower limit value	-2000		2000	
Process alarm lower upper limit value	-2000		2050	
Process alarm upper lower limit value	8500		2950	
Process alarm upper upper limit value	8500		3000	
Rate alarm warning output enable/disable setting	Disable	Disable	Disable	Enable
Rate alarm warning detection period	1	— Setting not required (Default value)	— Setting not required (Default value)	3
Rate alarm upper limit value	0			50
Rate alarm lower limit value	0			-50
Scaling valid/invalid setting	Invalid	Invalid	Invalid	Invalid
Scaling range lower limit value	0	Setting not required (Default value)	Setting not required (Default value)	Setting not required (Default value)
Scaling range upper limit value	0			
Scaling width lower limit value	0			
Scaling width upper limit value	0			
Conversion setting for disconnection detection	Down scale	Down scale	Down scale	Down scale
Conversion setting value for disconnection detection	0	—	—	—

* 1 The setting is used to switch the process alarm setting value input range. Use the same range set for the measurement range setting at the intelligent function module switch 1 and 2. (In this program example, "New JIS (-200 to 850°C)" is set.)

- 1) Click the Initial setting button of the setting target channel.
In this program example, CH1 to CH3 are the setting target.
Since CH4 to CH8 are not used, setting is not required.

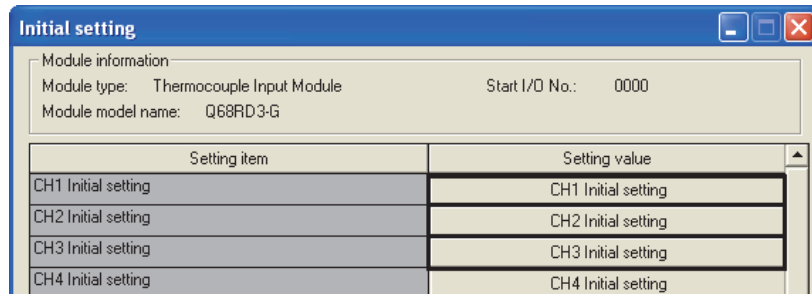

- 2) The following screen is displayed by clicking the Initial setting button of each channel. (The following is the example of CH1.)
Set the initial setting items listed in Table 6.3.

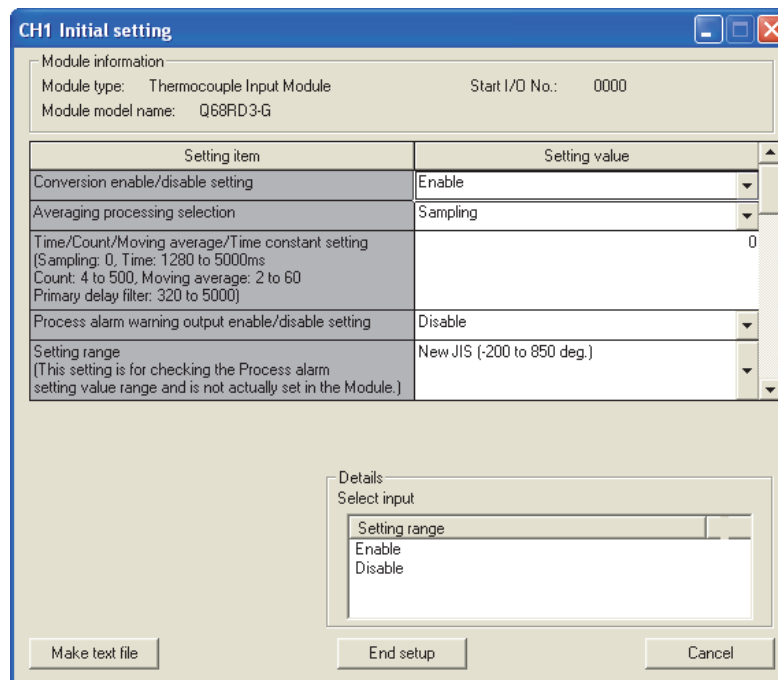

(b) Auto refresh setting (Refer to Section 5.5.)

Set devices in which the measured temperature values, warning output flags, disconnection detection flags, and error codes of CH1 to CH3 are to be stored. For the devices in the PLC side Device field, refer to "List of devices" at (1) in this section.

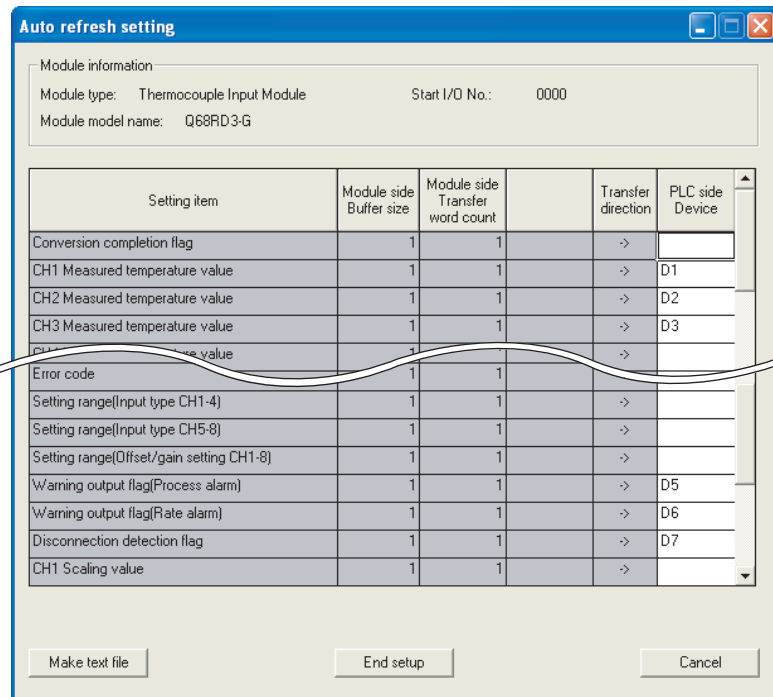

(c) Writing intelligent function module parameters (Refer to Section 5.3.3.)

Write the intelligent function module parameters to the CPU module. Perform this operation on the screen for selecting a target intelligent function module.

(3) Program example

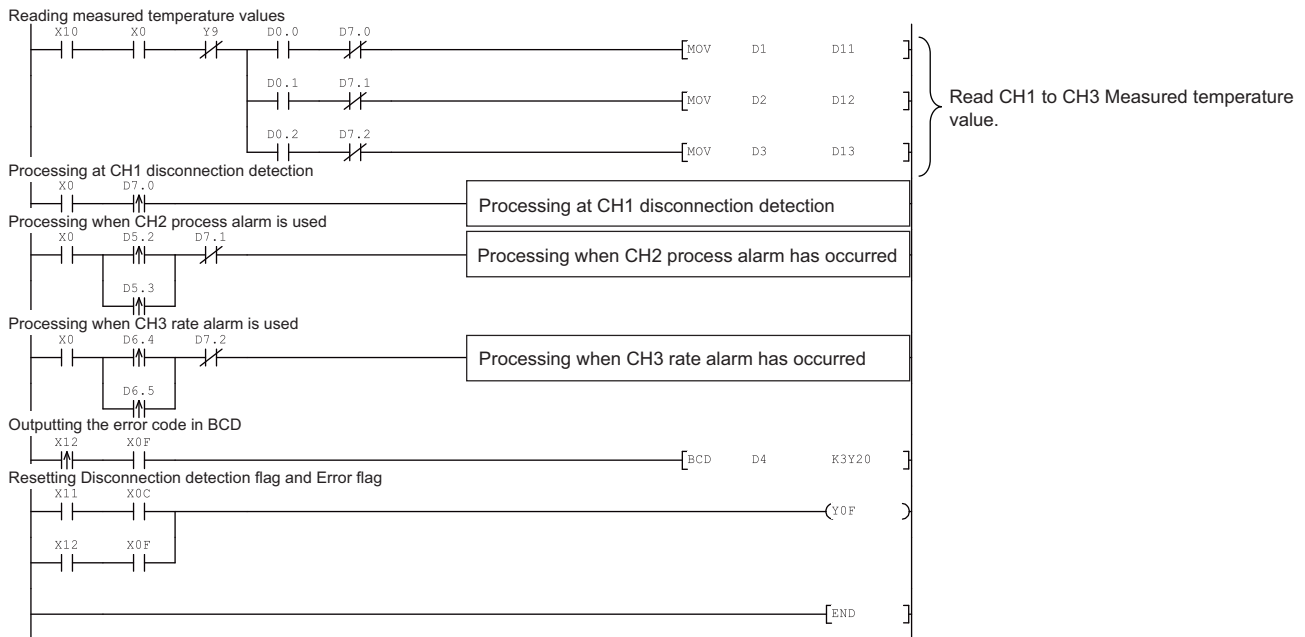

6.2.3 Program example when utility package is not used

(1) List of devices

Table 6.4 List of devices

Device	Function	
D11	CH1 Measured temperature value	
D12	CH2 Measured temperature value	
D13	CH3 Measured temperature value	
M0	Module ready check flag	
X0	Module ready	Q68RD3-G (X/Y0 to X/YF)
X9	Operating condition setting completion flag	
XC	Disconnection detection signal	
XF	Error flag	
Y9	Operating condition setting request	
YF	Error clear request	
X10	Device that user turns ON to start reading measured temperature values	QX10 (X10 to X1F)
X11	Device that user turns ON to reset a disconnection detection state	
X12	Device that user turns ON to reset an error	
Y20 to Y2B	Error code display (BCD 3 digits)	QY10 (Y20 to Y2F)

(2) List of buffer memory addresses to be used

Table 6.5 List of buffer memory addresses to be used

Address	Description	Setting value	Remarks
Un\G0 *1	Conversion enable/disable setting	00F8H	"Enable" is set to CH1 to CH3.
Un\G2	CH2 Time/Count/Moving average/Time constant setting	5	Count (times) is set when Count average is set.
Un\G3	CH3 Time/Count/Moving average/Time constant setting	960	Time constant (ms) is set when Primary delay filter is set.
Un\G10	Conversion completion flag	—	Conversion status of a channel is stored.
Un\G11	CH1 Measured temperature value		Measured temperature value is stored.
Un\G12	CH2 Measured temperature value		
Un\G13	CH3 Measured temperature value		
Un\G19	Error code		
Un\G24 *2	Averaging processing selection (CH1-CH4)	0420H	The following conversion system is set. CH1: Sampling processing CH2: Count average CH3: Primary delay filter
Un\G46 *3	Warning output enable/disable setting	FbfdH	"Enable" is set for the following warning output. CH2: Process alarm CH3: Rate alarm
Un\G47	Warning output flag (Process alarm)	—	Warning output status is stored.
Un\G48	Warning output flag (Rate alarm)		
Un\G49	Disconnection detection flag		Disconnection state of a channel is stored.
Un\G98	CH2 Process alarm lower lower limit value	2000	Values required to use CH2 process alarm are set.
Un\G99	CH2 Process alarm lower upper limit value	2050	
Un\G100	CH2 Process alarm upper lower limit value	2950	
Un\G101	CH2 Process alarm upper upper limit value	3000	
Un\G128	CH3 Rate alarm warning detection period	3	Values required to use CH3 rate alarm are set.
Un\G138	CH3 Rate alarm upper limit value	50	
Un\G139	CH3 Rate alarm lower limit value	-50	

* 1 Un\G0: Conversion enable/disable setting (Refer to Section 3.4.2.)

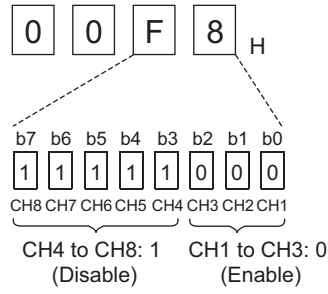

* 2 Un\G24: Averaging processing selection (CH1-CH4) (Refer to Section 3.4.9.)

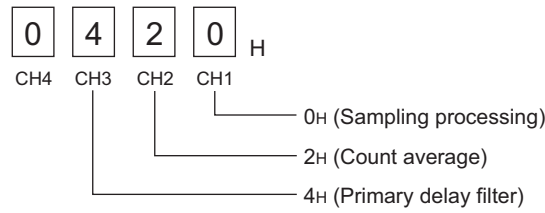

* 3 Un\G46: Warning output enable/disable setting (Refer to Section 3.4.12.)

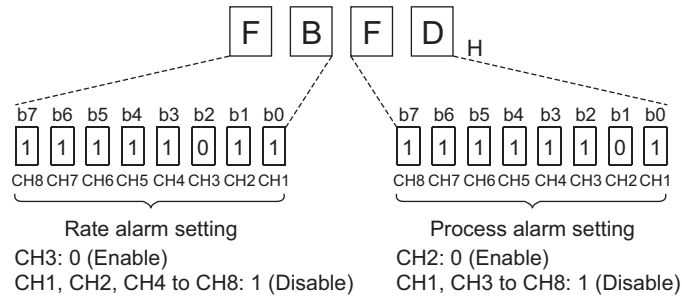

(3) Program example

Initial setting program of the Q68RD3-G

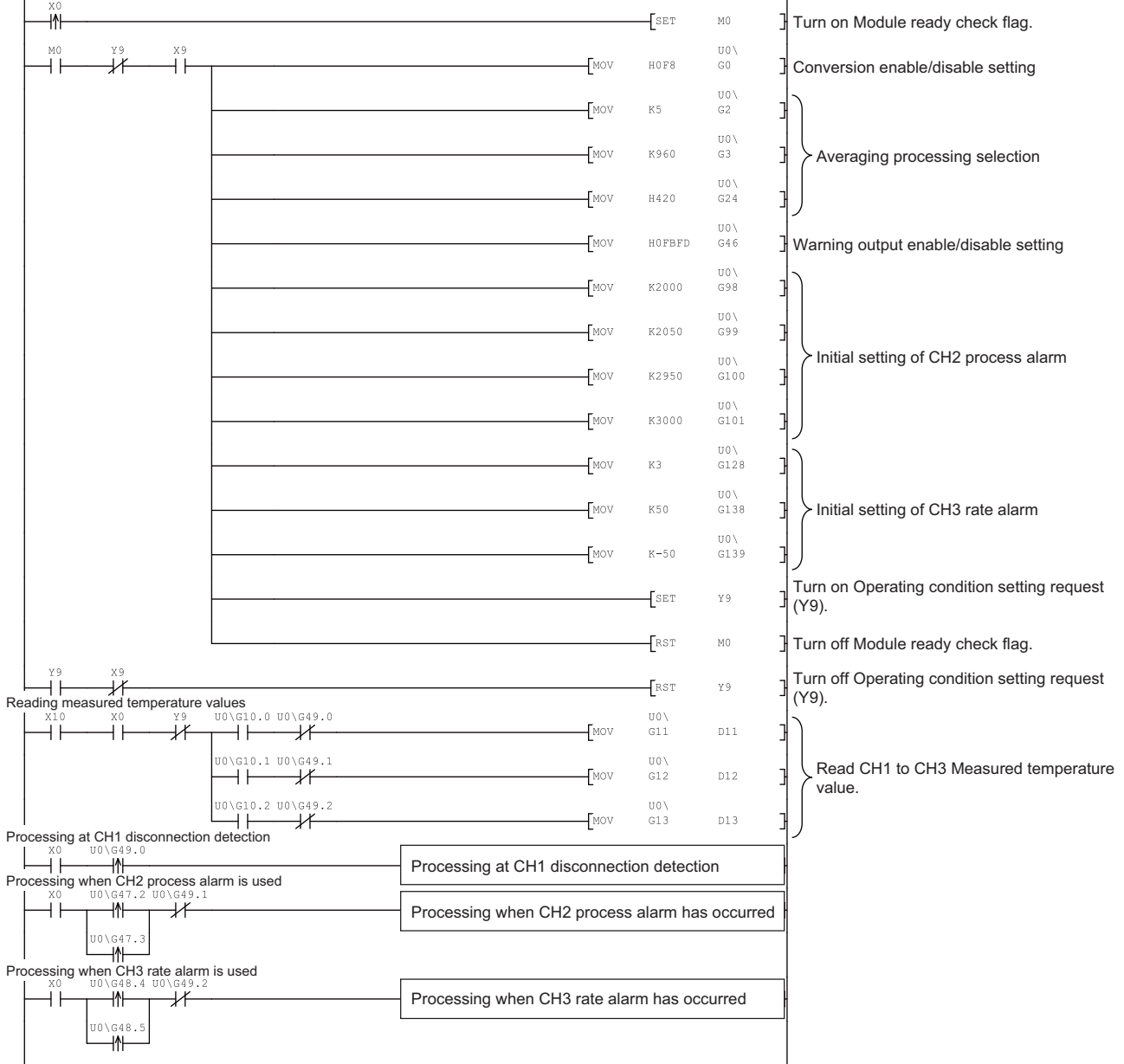

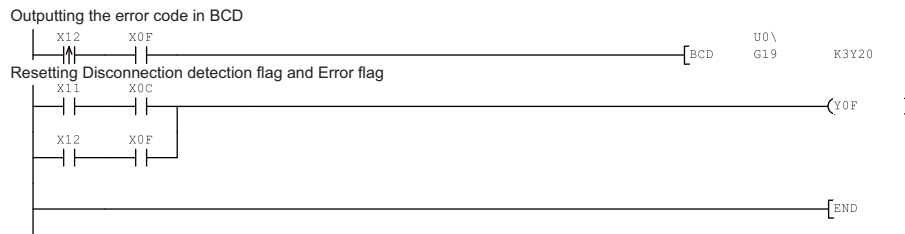

6.3 Using Programs on Remote I/O Network

This section describes program examples based on the following system configuration and conditions.

(1) System configuration

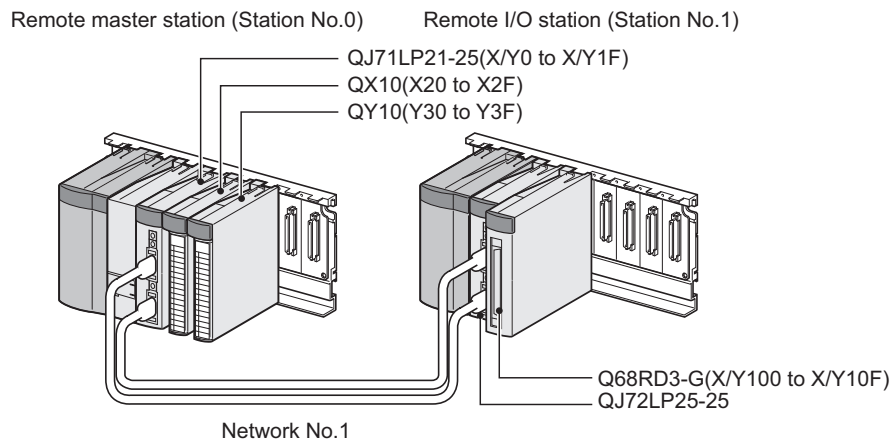

(2) Setting conditions for the intelligent function module switch setting

Table 6.6 Setting conditions for the intelligent function module switch setting

Channel	RTD (Measurement range)	Offset/gain setting
CH1	Pt100 (-200°C to 850°C)	Factory default setting
CH2		
CH3		
CH4 to CH8	Not used	—

(3) Programming conditions

- (a) Use the following temperature conversion system for each channel.
- CH1: Sampling processing
 - CH2: Count average (5 times)
 - CH3: Primary delay filter (Time constant 960ms)
- (b) Use the following function at each channel.
- CH2: Warning output function
 - Process alarm lower lower limit value: 2000 (200°C),
 - Process alarm lower upper limit value: 2050 (205°C),
 - Process alarm upper lower limit value: 2950 (295°C),
 - Process alarm upper upper limit value: 3000 (300°C)
 - CH3: Warning output function
 - Rate alarm warning detection period: 3 times (960ms),
 - Rate alarm lower limit value: -50 (-5.0°C),
 - Rate alarm upper limit value: 50 (+5.0°C)
- (c) Use the following setting for the Conversion setting for disconnection detection of CH1 to CH3.
- CH1 to CH3: Down scale (-252.5°C) [Default setting]
- (d) When a write error occurs, the corresponding error code is output to an output module in BCD value.
- (e) Perform the disconnection detection reset operation after the connection is re-established.

6.3.1 Before creating a program

This section describes the steps to be taken before creating a program.

(1) Wiring of external devices

Mount the Q68RD3-G onto the base unit and connect RTD (Pt100) to CH1 to CH3.
For details, refer to Section 6.2.1 (1).

(2) Intelligent function module switch setting

Based on the setting conditions given in Section 6.3 (2), make the intelligent function module switch setting.

For setting details of each switch, refer to Section 6.2.1 (2).

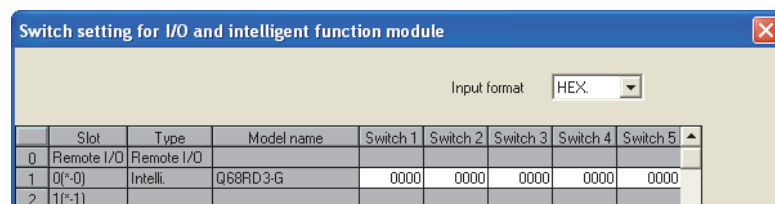

Slot	Type	Model name	Switch 1	Switch 2	Switch 3	Switch 4	Switch 5
0	Remote I/O	Remote I/O					
1	Q(*-0)	Intelli.	Q68RD3-G	0000	0000	0000	0000
2	1(*-1)						

Write the intelligent function module parameters to the remote I/O station.

☒ POINT

For details on the MELSECNET/H remote I/O network, refer to the Q Corresponding MELSECNET/H Network System Reference Manual (Remote I/O Network).

6.3.2 Program example when utility package is used

(1) List of devices

Table 6.7 List of devices

Device	Function	
W0	Device that Conversion completion flag is written by auto refresh	
W1	Device that CH1 Measured temperature value is written by auto refresh	
W2	Device that CH2 Measured temperature value is written by auto refresh	
W3	Device that CH3 Measured temperature value is written by auto refresh	
W4	Device that Error code is written by auto refresh	
W5	Device that Warning output flag (Process alarm) is written by auto refresh	
W6	Device that Warning output flag (Rate alarm) is written by auto refresh	
W7	Device that Disconnection detection flag is written by auto refresh	
D11	CH1 Measured temperature value	
D12	CH2 Measured temperature value	
D13	CH3 Measured temperature value	
X20	Device that user turns ON to start reading measured temperature values	QX10 (X20 to X2F)
X21	Device that user turns ON to reset a disconnection detection state	
X22	Device that user turns ON to reset an error	
Y30 to Y3B	Error code display (BCD 3 digits)	QY10 (Y30 to Y3F)
X100	Module ready	Q68RD3-G (X/Y100 to X/Y10F)
X10C	Disconnection detection signal	
X10F	Error flag	
Y10F	Error clear request	

(2) GX Developer operation (Network parameter setting)

- Network type : MNET/H [Remote master]
- Starting I/O No. : 0000H
- Network No. : 1
- Total stations : 1
- Mode : Online
- Network range assignment :

StationNo.	M station -> R station						M station <- R station					
	Y			Y			X			X		
	Points	Start	End	Points	Start	End	Points	Start	End	Points	Start	End
1	256	0100	01FF	256	0000	00FF	256	0100	01FF	256	0000	00FF

StationNo.	M station -> R station			M station <- R station			M station -> R station			M station <- R station		
	B			B			W			W		
	Points	Start	End	Points	Start	End	Points	Start	End	Points	Start	End
1							160	0100	019F	160	0000	009F

- Refresh parameters:

Assignment method

Points/Start

Start/End

Transient transmission error history status

Overwrite Hold

	Link side					PLC side			
	Dev. name	Points	Start	End		Dev. name	Points	Start	End
Transfer SB	SB	512	0000	01FF	↔	SB	512	0000	01FF
Transfer S/W	S/W	512	0000	01FF	↔	S/W	512	0000	01FF
Random cyclic	LB				↔				
Random cyclic	LW				↔				
Transfer1	LB	8192	0000	1FFF	↔	B	8192	0000	1FFF
Transfer2	LW	8192	0000	1FFF	↔	W	8192	0000	1FFF
Transfer3	LX	256	0100	01FF	↔	X	256	0100	01FF
Transfer4	LY	256	0100	01FF	↔	Y	256	0100	01FF
Transfer5					↔				
Transfer6					↔				

(3) Utility package operation

Operation is performed on the remote I/O station side.

(a) Initial setting (Refer to Section 5.4.)

Set the initial settings of CH1 to CH3.

For setting details, refer to Section 6.2.2 (2).

(b) Auto refresh setting (Refer to Section 5.5.)

Set devices in which the measured temperature values, warning output flags, disconnection detection flags, and error codes of CH1 to CH3 are stored.

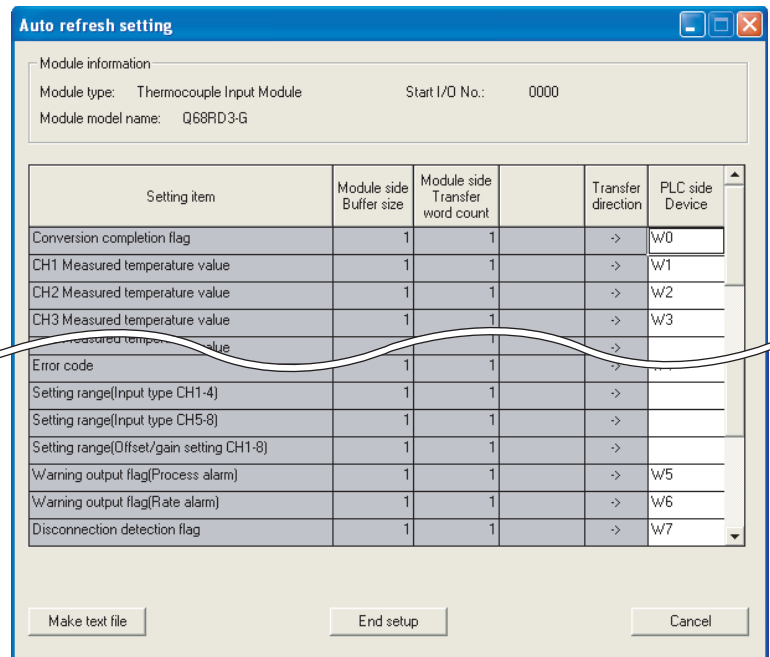

(c) Writing intelligent function module parameters (Refer to Section 5.3.3.)

Write the intelligent function module parameters to the remote I/O station. Perform this operation on the screen for selecting a target intelligent function module.

POINT

To write the intelligent function module parameters, set a target remote I/O station on the screen displayed by selecting [Online] - [Transfer setup] in GX Developer.

The intelligent function module parameters can be written by:

- Directly connecting GX Developer to the remote I/O station.
- Routing the network to the remote I/O station by connecting GX Developer to another device, such as a CPU module.

(4) Program example

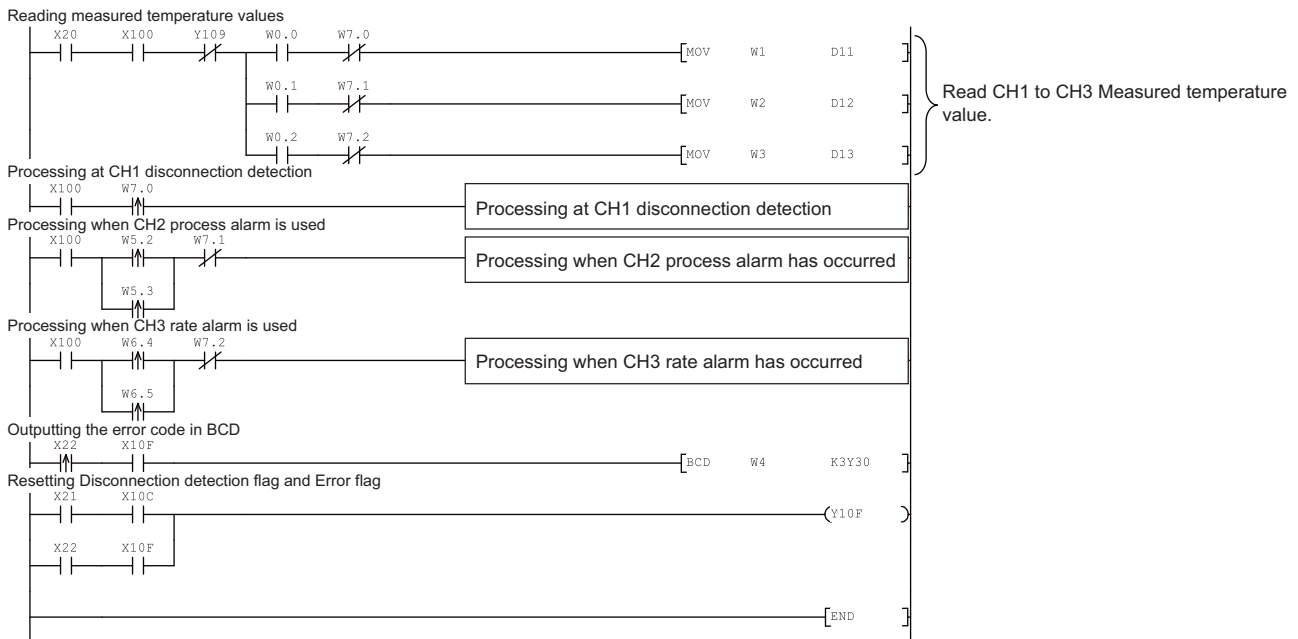

6.3.3 Program example when utility package is not used

(1) List of devices

Table 6.8 List of devices

Device	Function
D11	CH1 Measured temperature value
D12	CH2 Measured temperature value
D13	CH3 Measured temperature value
X20	Device that user turns ON to start reading measured temperature value
X21	Device that user turns ON to reset a disconnection detection state
X22	Device that user turns ON to reset an error
Y30 to Y3B	Error code display (BCD 3 digits)
X100	Module ready
X109	Operating condition setting completion flag
X10C	Disconnection detection signal
X10F	Error flag
Y109	Operating condition setting request
Y10F	Error clear request
M100	Master module status check device (for the MC and MCR instructions)
M101	Initial setting auxiliary device
M102	
M103	
M104	
M200 to M202	Z(P).REMTO instruction completion device
M210 to M212	
M220 to M222	
M230 to M232	
M240 to M242	
M300 to M302	Z(P).REMFR instruction completion device
M310 to M312	
D1000 to D1003	Write data storage device for REMTO instruction (for initial setting)
D1024	
D1046	
D1098 to D1101	
D1128 to D1139	
D2010 to D2050	Read data storage device for REMFR instruction (for Conversion completion flag, Measured temperature value, and Error code)
SB20	Network module status
SB47	Baton pass status of own station
SB49	Data link status of own station
SW70	Baton pass status of each station
SW74	Cyclic transmission status of each station
SW78	Parameter communication status of each station
T100 to T104	Interlock for own station and other stations

1

OVERVIEW

2

SYSTEM CONFIGURATION

3

SPECIFICATIONS

4

PROCEDURES AND SETTINGS BEFORE SYSTEM OPERATION

5

UTILITY PACKAGE (GX CONFIGURATOR-T)

6

PROGRAMMING

7

ONLINE MODULE CHANGE

8

TROUBLESHOOTING

(2) List of buffer memory addresses to be used

The Z(P).REMFR or Z(P).REMTO instruction is used to access to the buffer memory of the Q68RD3-G.

Check the access device in the "Address (Device)" column in Table 6.9.

Table 6.9 List of buffer memory addresses to be used

Address (Device)	Description	Setting value	Remarks
Un\G0(D1000)* ¹	Conversion enable/disable setting	00F8H	"Enable" is set to CH1 to CH3.
Un\G2(D1002)	CH2 Time/Count/Moving average/Time constant setting	5	Count (times) is set when Count average is set.
Un\G3(D1003)	CH3 Time/Count/Moving average/Time constant setting	960	Time constant (ms) is set when Primary delay filter is set.
Un\G10(D2010)	Conversion completion flag	—	Conversion status of a channel is stored.
Un\G11(D2011)	CH1 Measured temperature value		Measured temperature value is stored.
Un\G12(D2012)	CH2 Measured temperature value		
Un\G13(D2013)	CH3 Measured temperature value		
Un\G19(D2050)	Error code		
Un\G24 (D1024, D2024)* ^{2,4}	Averaging processing selection (CH1-CH4)	0420H	
Un\G46 (D1046, D2046)* ^{3,4}	Warning output enable/disable setting	FBFDH	"Enable" is set for the following warning output. CH2: Process alarm CH3: Rate alarm
Un\G47(D2047)	Warning output flag (Process alarm)	—	Warning output status is stored.
Un\G48(D2048)	Warning output flag (Rate alarm)		
Un\G49(D2049)	Disconnection detection flag		
Un\G98(D1098)	CH2 Process alarm lower lower limit value	2000	Values required to use CH2 process alarm are set.
Un\G99(D1099)	CH2 Process alarm lower upper limit value	2050	
Un\G100(D1100)	CH2 Process alarm upper lower limit value	2950	
Un\G101(D1101)	CH2 Process alarm upper upper limit value	3000	
Un\G128(D1128)	CH3 Rate alarm warning detection period	3	
Un\G138(D1138)	CH3 Rate alarm upper limit value	50	
Un\G139(D1139)	CH3 Rate alarm lower limit value	-50	

* 1 Un\G0: Conversion enable/disable setting (Refer to Section 3.4.2.)

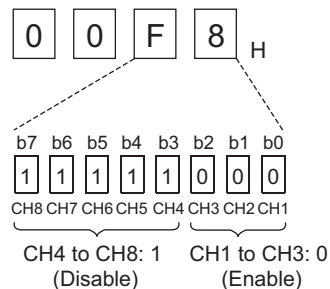

* 2 Un\G24: Averaging processing selection (CH1-CH4) (Refer to Section 3.4.9.)

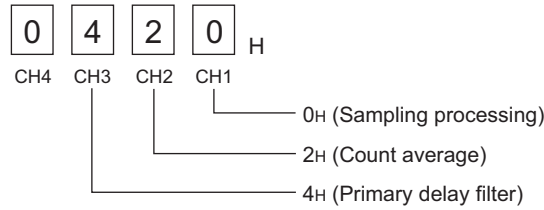

* 3 Un\G46: Warning output enable/disable setting (Refer to Section 3.4.12.)

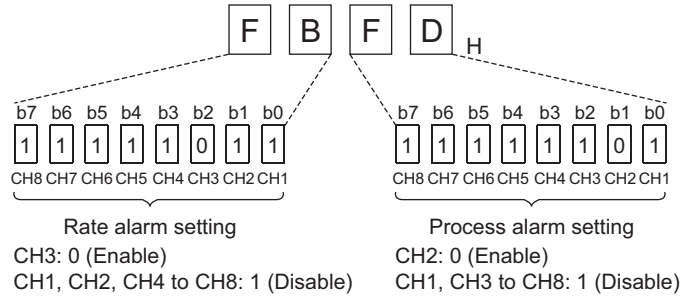

* 4 D1024 and D1046 are used for writing the initial setting data. (D2024 and D2046 are used for reading the initial setting data.)

(3) GX Developer operation (Network parameter setting)

- Network type : MNET/H [Remote master]
- Starting I/O No. : 0000H
- Network No. : 1
- Total stations : 1
- Mode : Online
- Network range assignment :

StationNo.	M station -> R station						M station <- R station					
	Y			Y			X			X		
	Points	Start	End	Points	Start	End	Points	Start	End	Points	Start	End
1	256	0100	01FF	256	0000	00FF	256	0100	01FF	256	0000	00FF

StationNo.	M station -> R station			M station <- R station			M station -> R station			M station <- R station		
	B			B			W			W		
	Points	Start	End	Points	Start	End	Points	Start	End	Points	Start	End
1							160	0100	019F	160	0000	009F

- Refresh parameters:

	Link side				PLC side			
	Dev. name	Points	Start	End	Dev. name	Points	Start	End
Transfer SB	SB	512	0000	01FF	SB	512	0000	01FF
Transfer SW	SW	512	0000	01FF	SW	512	0000	01FF
Random cyclic	LB							
Random cyclic	LW							
Transfer1	LB	8192	0000	1FFF	B	8192	0000	1FFF
Transfer2	LW	8192	0000	1FFF	w	8192	0000	1FFF
Transfer3	LX	256	0100	01FF	X	256	0100	01FF
Transfer4	LY	256	0100	01FF	Y	256	0100	01FF
Transfer5								
Transfer6								

(4) Program example

Checking remote I/O station operation status

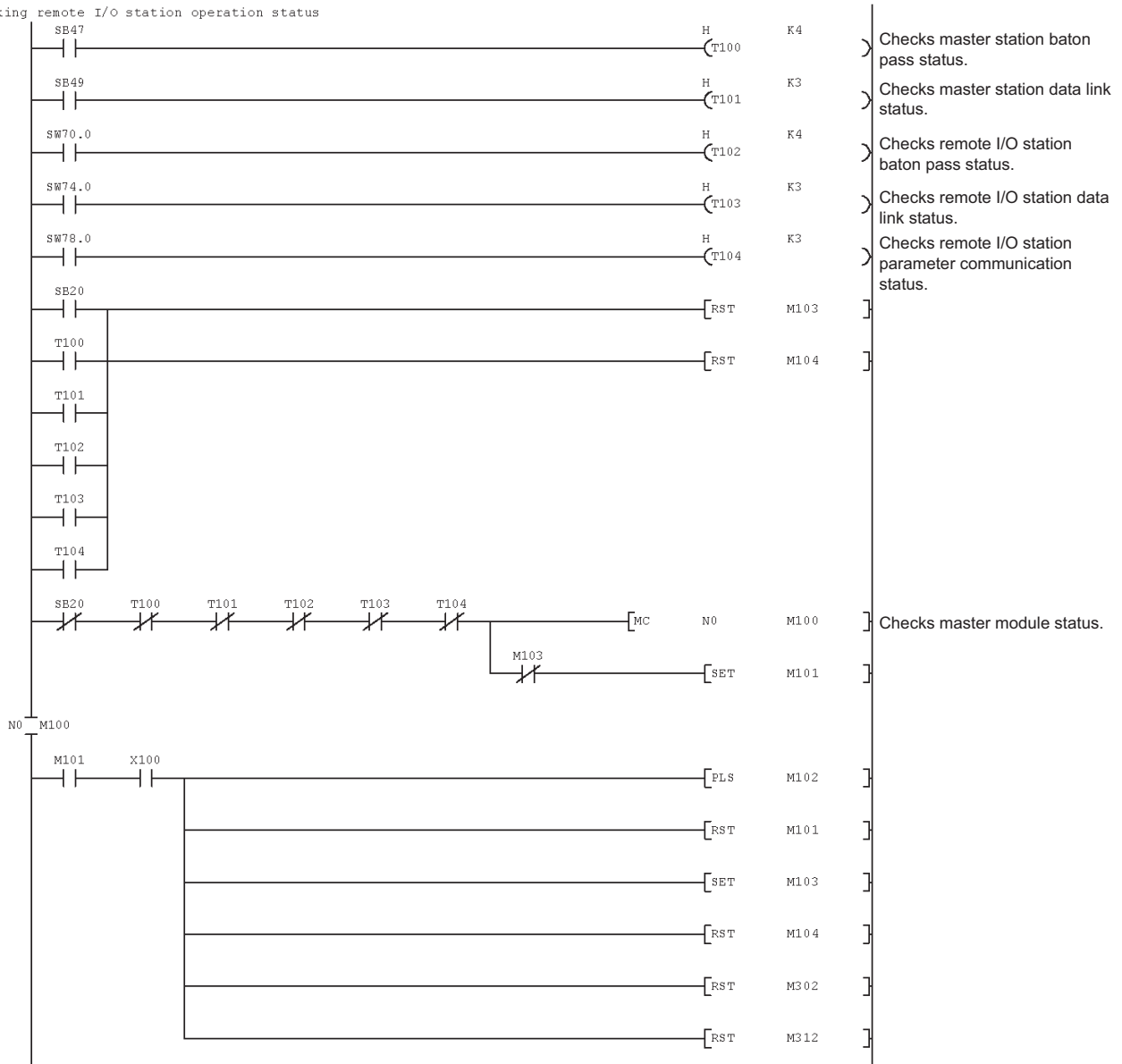

Initial setting of the Q68RD3-G
Writing initial setting #1 to Un\G0 to Un\G3

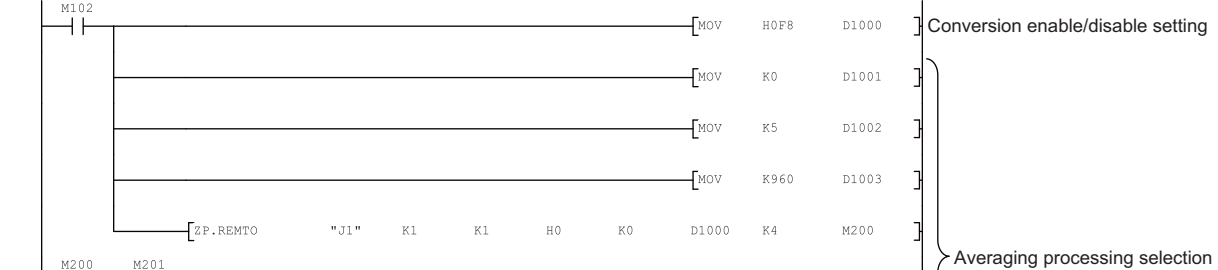

Writing initial setting #2 to Un\G24



Writing initial setting #3 to Un\G46

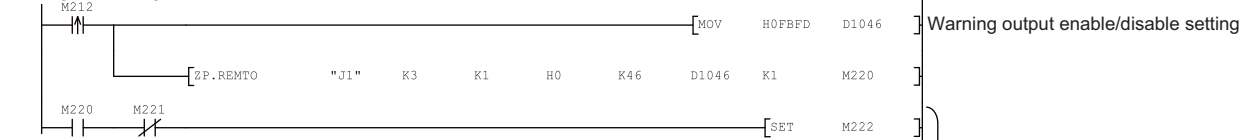

Writing initial setting #4 to Un\G98 to Un\G101

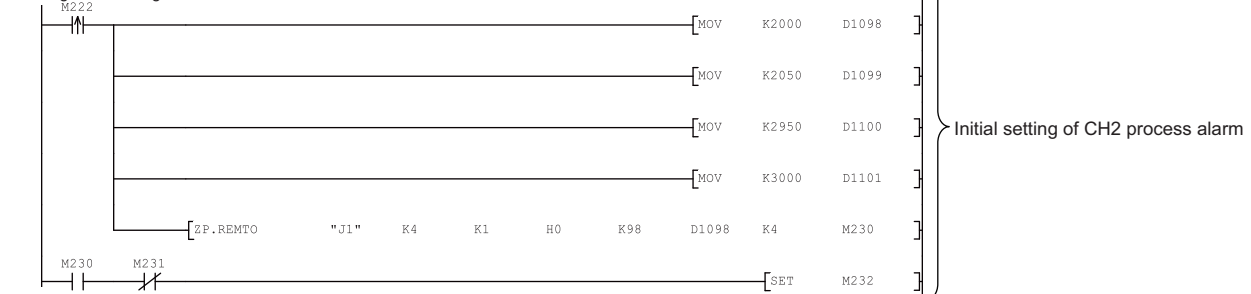

Writing initial setting #5 to Un\G128 to Un\G139

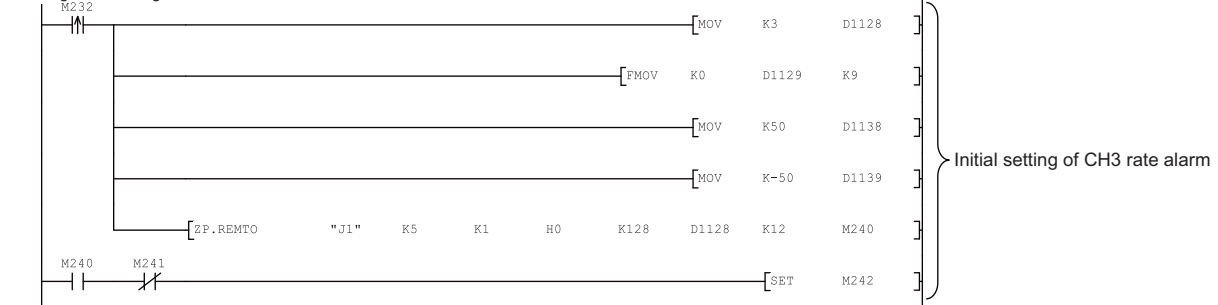

Turning on Operating condition setting request (Y9)
after writing of all initial setting data #1 to #5 are normally completed

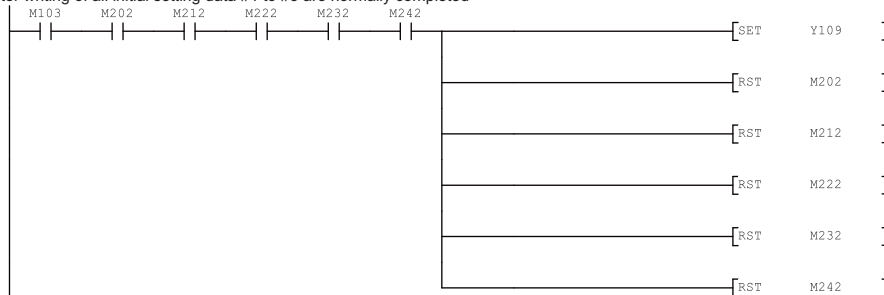

Reading Conversion completion flag,
Measured temperature value, Warning output flag, and Disconnection detection flag

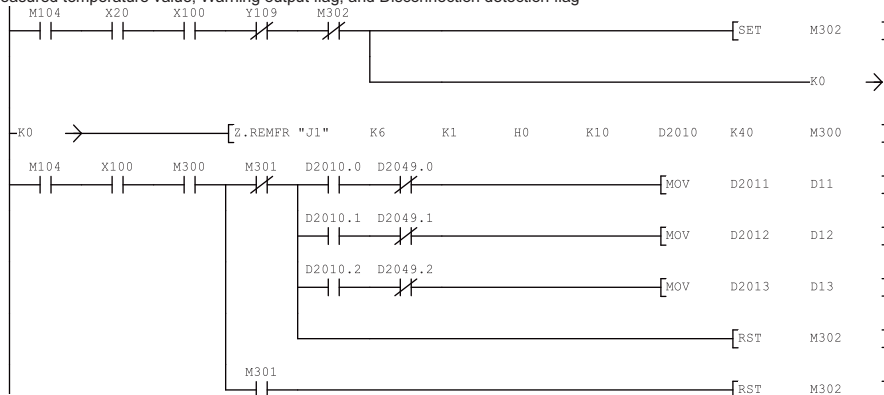

Read CH1 to CH3 Measured temperature value.

Processing at CH1 disconnection detection



Processing when CH2 process alarm is used



Processing when CH3 rate alarm is used



Outputting the error code in BCD



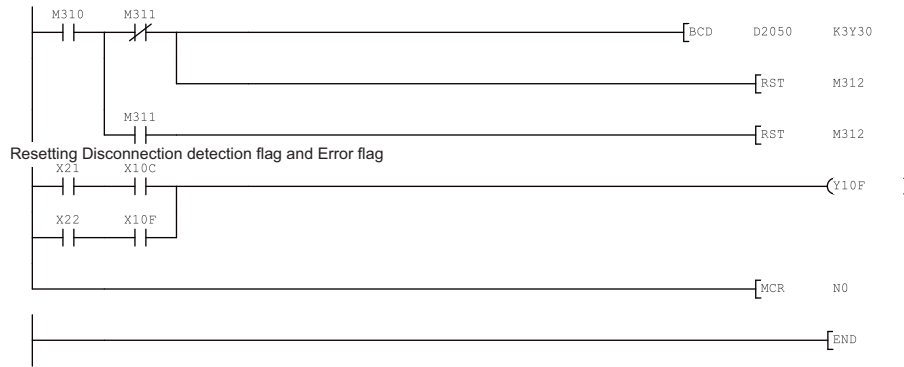

1

OVERVIEW

2

SYSTEM CONFIGURATION

3

SPECIFICATIONS

4

PROCEDURES AND SETTINGS BEFORE SYSTEM OPERATION

5

UTILITY PACKAGE (GX CONFIGURATOR-TI)

6

PROGRAMMING

7

ONLINE MODULE CHANGE

8

TROUBLESHOOTING

CHAPTER7 ONLINE MODULE CHANGE

When changing a module online, carefully read the "Online module change" section of the QCPU User's Manual (Hardware Design, Maintenance and Inspection).

This chapter describes the specifications of online module change.

- (1) Perform an online module change operation using GX Developer.**
- (2) Dedicated instructions or the user range save/restore functions which read/write data from/to buffer memory are provided so that re-setting of offset/gain values can be performed easily.**

☒ POINT

- (1) Make sure that the system outside the programmable controller will not malfunction before performing online module change.
- (2) To prevent an electric shock and malfunction of operating modules, provide means such as switches for powering OFF the external power supply of the module to be changed online and the power supply for external devices, individually.
- (3) After the module has failed, data may not be saved properly. Referring to Section 3.4.25, take a note of values to be saved in advance (such as Factory default offset/gain values, User range settings offset/gain values, User range settings resistance offset/gain values in buffer memory (Un\G190 to Un\G253)).
- (4) It is recommended to perform online module change in the actual system in advance to ensure that changing a module would not affect the operation of the modules not targeted for online module change by checking the following:
 - Means of disconnecting external devices and its configuration are correct.
 - Switching ON/OFF does not bring any undesirable effect.
- (5) Do not install/remove the module to/from the base unit more than 50 times after the first use of the product. (IEC 61131-2 compliant)
Failure to do so may cause malfunction.

(Note)

Dedicated instructions cannot be executed during online module change. When using dedicated instructions to save/restore the setting values, execute them in a separate system*.

If a separate system is unavailable, restore values by writing them to the buffer memory.

* Even when the module is mounted to the remote I/O station, use dedicated instructions to save/restore the setting values in a separate system where the module is mounted on the main base unit. (Data cannot be saved/restored in a separate system mounted on the remote I/O station.)

7.1 Conditions Required for Online Module Change

The CPU module, MELSECNET/H remote I/O module, Q68RD3-G, GX Developer, and base unit described below are required to perform online module change.

(1) CPU module

The Process CPU or Redundant CPU are required.

For precautions on multiple CPU system configuration, refer to the QCPU User's Manual (Multiple CPU System).

For precautions on redundant system configuration, refer to the QnPRHCPU User's Manual (Redundant System).

(2) MELSECNET/H remote I/O module

The module of function version D or later is required.

(3) GX Developer

GX Developer of Version 7.10L or later is required.

GX Developer of Version 8.18U or later is required to perform online module change on the remote I/O station.

(4) Base unit

(a) When a slim type main base unit (Q3□SB) is used, online module change cannot be performed.

(b) When an extension base unit (type not requiring power supply module) (Q5□B) is used, online module change cannot be performed for the modules on all the base units connected.

Remark

The function version of the Q68RD3-G has been "C" from the first release, supporting online module change.

7.2 Operations during Online Module Change

The following table shows the operations performed during online module change.

Table 7.1 Online module change operation

CPU operation ○: Executable ×: Not executable						(User operation)	(Intelligent function module operation)
X/Y refresh	FROM/TO instructions *1	Dedicated instruction	Device test	GX Configurator			
				Initial setting parameter	Monitor/test		
○	○	○	○	×	○	<p>(1) Disabling conversion</p> <p>Turn OFF all Y signals that have been turned ON by a sequence program.</p> <p>(2) Removing a module</p> <p>Start an online module change operation using GX Developer.</p> <p>Click the "Execution" button on the screen to enable a module change.</p> <p>Remove the target module.</p> <p>(3) Mounting a new module</p> <p>Mount a new module.</p> <p>After mounting the module, click the "Execution" button on the screen of GX Developer.</p> <p>Operation check before start of control</p> <p>(4) Checking operation</p> <p>Click the "Cancel" button to leave the online module change mode.</p> <p>Conduct an operation test on the new module using "Device test" of GX Developer or "Monitor/Test" of GX Configurator.</p> <p>(Perform user range restoration processing by writing data to buffer memory at this point.)</p> <p>Completion of operation check</p> <p>(5) Restarting control</p> <p>Resume the online module change mode using GX Developer and click the "Execution" button to restart control.</p>	<p>Module operates normally.</p> <p>Module stops operation.</p> <ul style="list-style-type: none"> · "RUN" LED is off. · Conversion is disabled. <p>X/Y refresh resumes and module starts operation.</p> <ul style="list-style-type: none"> · "RUN" LED is on. · Module operates with default settings. (X0 remains OFF.) (If initial setting parameters have been set, module operates according to them at this point.) <p>Module operates according to test operation. *2</p> <p>Module ready (X0) turns ON.</p> <p>Module operates according to sequence program which performs initial setting on the rising edge of X0. *2</p>
×	×	×	×	×	×		
○	×	×	×	○	×		
○	×	×	○	×	○		
○	○	○	○	×	○		

* 1 Access to the intelligent function module device (U□\G□) is included.

* 2 If the operation marked *2 is not performed, the intelligent function module operates with the operation performed prior to that.

7.3 Procedures of Online Module Change

This section describes procedures of online module change depending on the combination of the range setting type, the initial setting method, and the availability of separate system, as shown in the following table.

Table 7.2 Online module change procedures

Range setting	Initial setting	Separate system	Reference
Factory default	GX Configurator-TI	—	Section 7.3.1
Factory default	Sequence program	—	Section 7.3.2
User range setting	GX Configurator-TI	Available	Section 7.3.3
User range setting	GX Configurator-TI	Not available	Section 7.3.4
User range setting	Sequence program	Available	Section 7.3.5
User range setting	Sequence program	Not available	Section 7.3.6

7.3.1 When factory default is used and initial setting has been made with GX Configurator-TI

(1) Disabling conversion

- (a) Set the Conversion enable/disable setting (Un\G0) to "Disable" for all channels and turn Operating condition setting request (Y9) from OFF to ON to stop conversion.

After confirming that conversion has stopped with the Conversion completion flag (Un\G10), turn OFF Operating condition setting request (Y9).

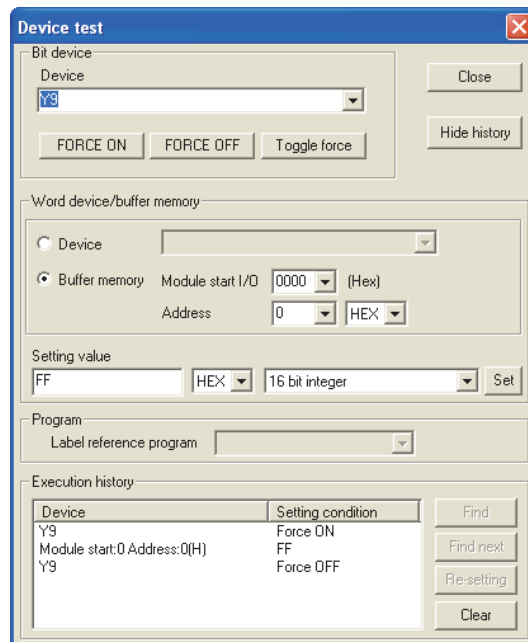

(2) Removing a module

- (a) On the screen displayed by selecting [Diagnosis] - [Online module change] in GX Developer, select the "Online module change" mode and double-click the module to be changed online to display the "Online module change" screen.

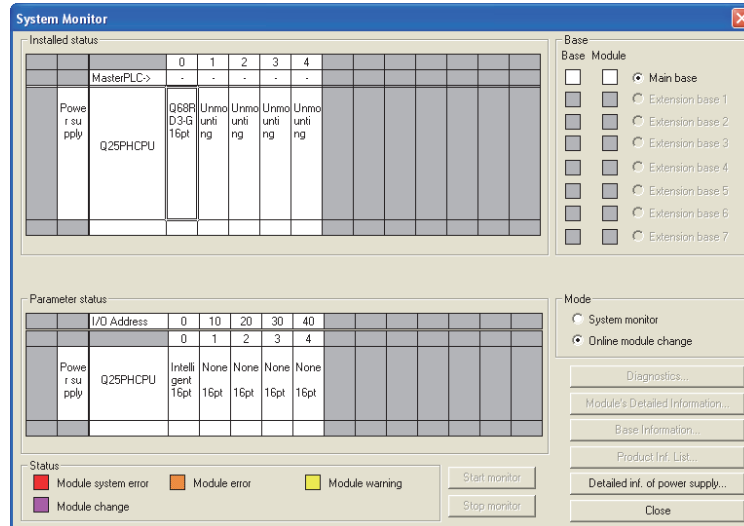

- (b) Click the **Execution** button to enable a module change.

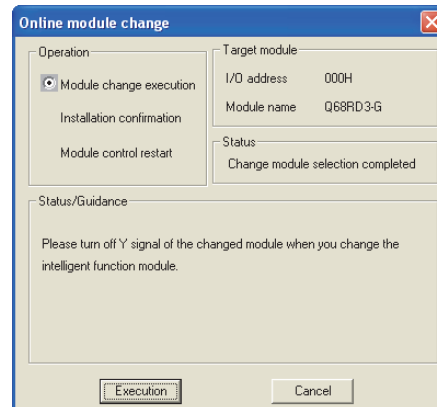

If the following screen appears, click the **OK** button, remove the module, and mount a new module.

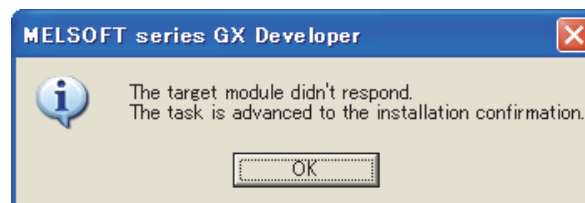

- (c) After confirming that the "RUN" LED of the module has turned off, disconnect the connector and remove the module.

POINT

Make sure to remove the module. If the mounting status is confirmed ("Installation confirmation" is executed) without removing the module, the module will not start properly and the "RUN" LED will not turn on.

(3) Mounting a new module

- (a) Mount a new module to the same slot and connect the connector.
- (b) After mounting the module, click the **Execution** button and confirm that the "RUN" LED is on. Module ready (X0) remains OFF.

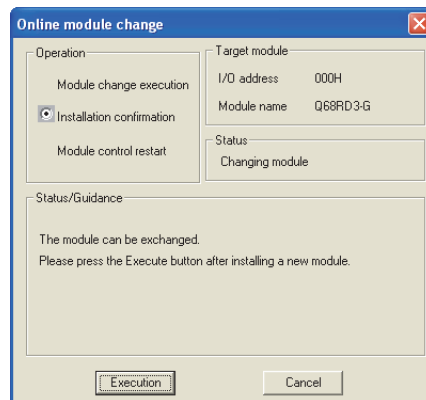

(4) Checking operation

- (a) For checking operation, click the **Cancel** button to cancel the restart of control to the module.

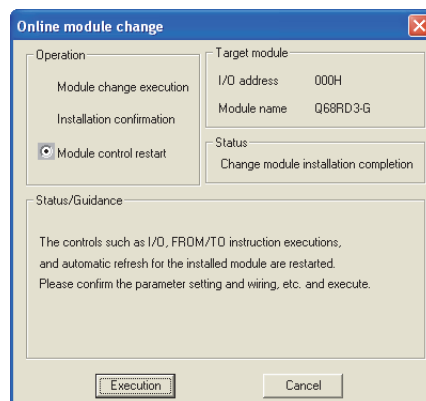

- (b) Click the **OK** button to leave the "Online module change" mode.

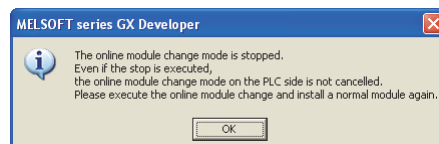

(c) Click the button to close the "System monitor" screen.

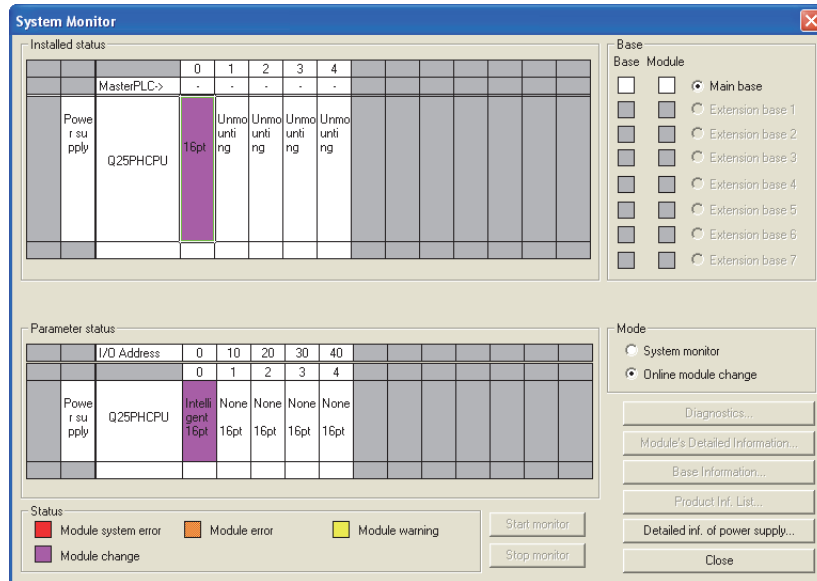

(d) Monitor the CH \square Measured temperature value (Un\G11 to Un\G18) to check that conversion has been made properly.

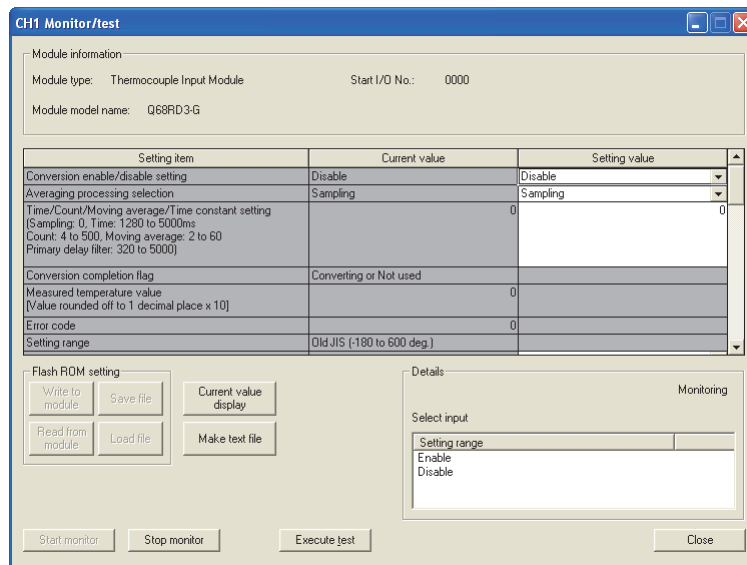

(5) Restarting control

- (a) Display the "Online module change" screen again from the screen displayed by selecting [Diagnosis] - [Online module change] in GX Developer and click the

 button to restart control. Module ready (X0) turns on.

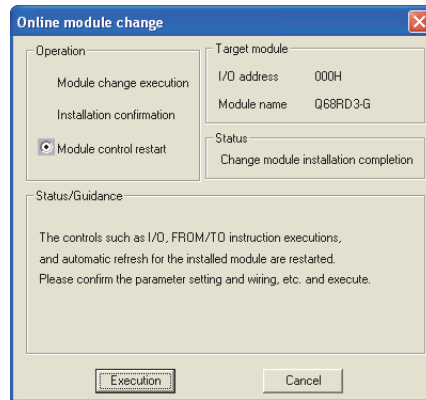

- (b) The following screen appears.



7.3.2 When factory default is used and initial setting has been made with sequence program

(1) Disabling conversion

- (a) Set the Conversion enable/disable setting (Un\G0) to "Disable" for all channels and turn Operating condition setting request (Y9) from OFF to ON to stop conversion.

After confirming that conversion has stopped with the Conversion completion flag (Un\G10), turn OFF Operating condition setting request (Y9).

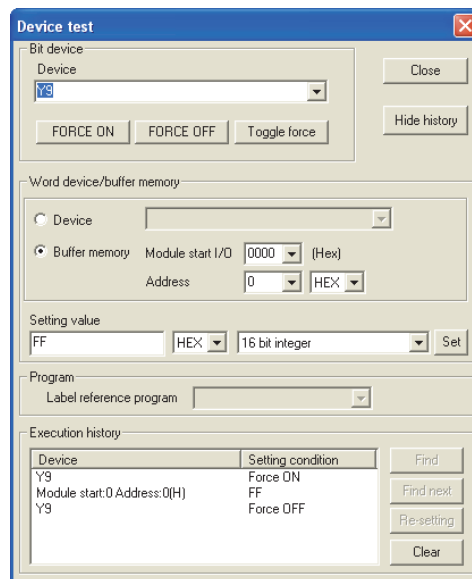

(2) Removing a module

- (a) On the screen displayed by selecting [Diagnosis] - [Online module change] in GX Developer, select the "Online module change" mode and double-click the module to be changed online to display the "Online module change" screen.

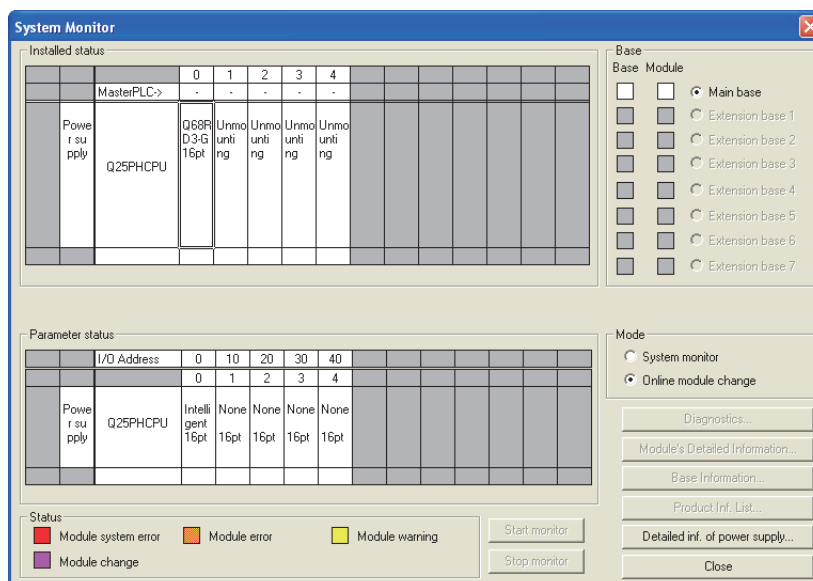

- (b) Click the **Execution** button to enable a module change.

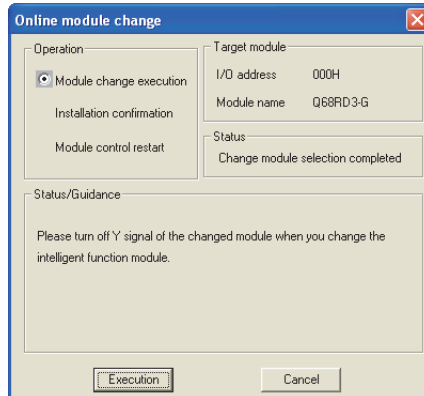

If the following screen appears, click the **OK** button, remove the module, and mount a new module.

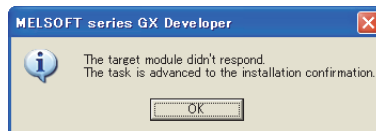

- (c) After confirming that the "RUN" LED of the module has turned off, disconnect the connector and remove the module.

POINT

Make sure to remove the module. If the mounting status is confirmed ("Installation confirmation" is executed) without removing the module, the module will not start properly and the "RUN" LED will not turn on.

(3) Mounting a new module

- (a) Mount a new module to the same slot and connect the connector.
- (b) After mounting the module, click the **Execution** button and confirm that the "RUN" LED is on. Module ready (X0) remains OFF.

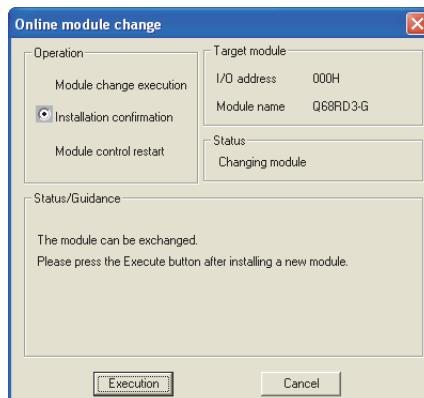

(4) Checking operation

- (a) For checking operation, click the  button to cancel the restart of control to the module.

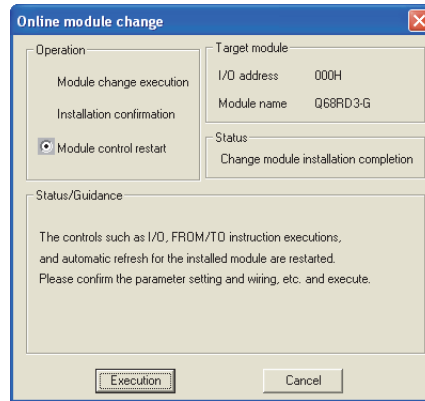

- (b) Click the  button to leave the "Online module change" mode.

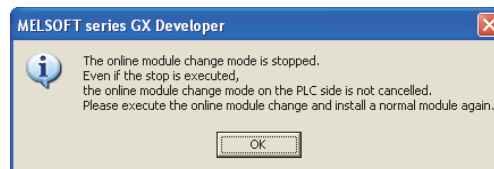

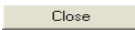
- (c) Click the  button to close the "System monitor" screen.

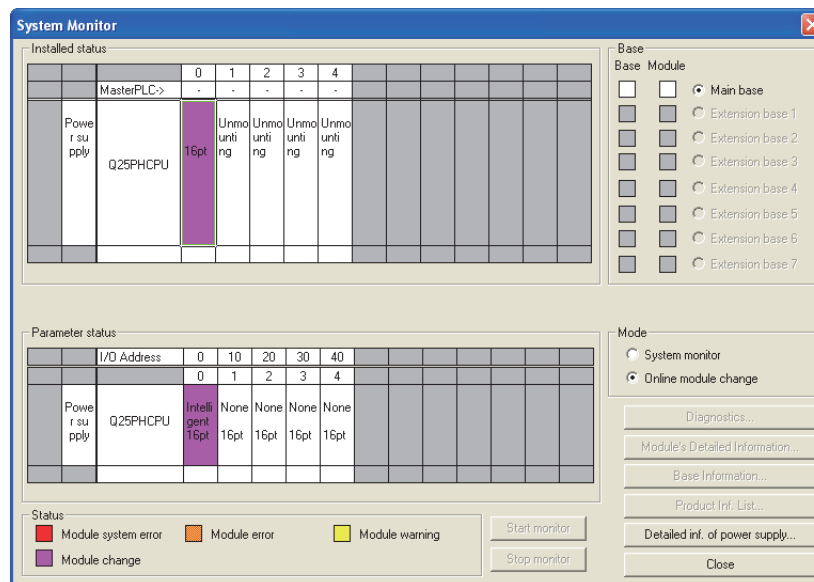

- (d) Enable the conversion of the channel to be used in Conversion enable/disable setting (Un\G0), and turn Operating condition setting request (Y9) from OFF to ON. Monitor CH□ Measured temperature value (Un\G11 to Un\G18) to check if the conversion is processed normally.
- (e) Since the new module is in a default state, initial setting must be performed by a sequence program after the restart of control.
Before performing initial setting, check that the contents of an initial setting program are correct.
 - 1) When a module is used in normal system configuration
Create a sequence program so that initial setting is performed on the rising edge of Module ready (X9) of the Q68RD3-G.
When control is restarted, Module ready (X0) turns ON and initial setting is performed. (If the sequence program performs initial setting only for one scan after RUN, initial setting will not be performed.)
 - 2) When a module is used on remote I/O network
Insert a user device that will perform initial setting at any timing (Initial setting request signal) into a sequence program. After the restart of control, turn ON Initial setting request signal to perform initial setting. (If the sequence program performs initial setting only for one scan after a data link start of the remote I/O network, initial setting will not be performed.)

(5) Restarting control

- (a) Display the "Online module change" screen again from the screen displayed by selecting [Diagnosis] - [Online module change] in GX Developer and click the  button to restart control. Module ready (X0) turns on.

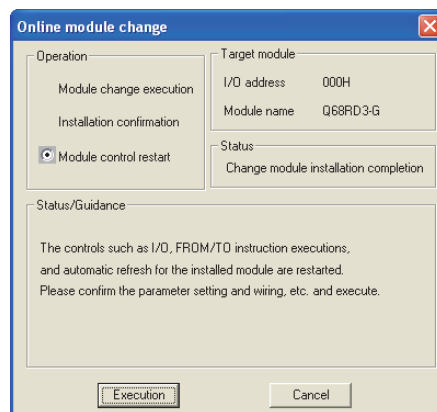

- (b) The following screen appears.



7.3.3 When user range setting is used and initial setting has been made with GX Configurator-TI (Separate system is available)

(1) Disabling conversion

- (a) Set the Conversion enable/disable setting (Un\G0) to "Disable" for all channels and turn Operating condition setting request (Y9) from OFF to ON to stop conversion.

After confirming that conversion has stopped with the Conversion completion flag (Un\G10), turn OFF Operating condition setting request (Y9).

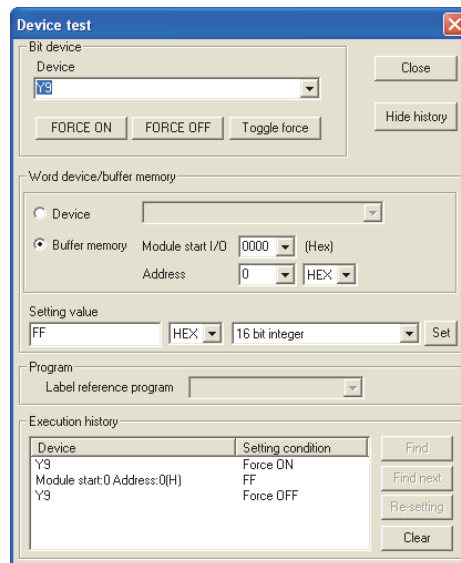

(2) Removing a module

- (a) On the screen displayed by selecting [Diagnosis] - [Online module change] in GX Developer, select the "Online module change" mode and double-click the module to be changed online to display the "Online module change" screen.

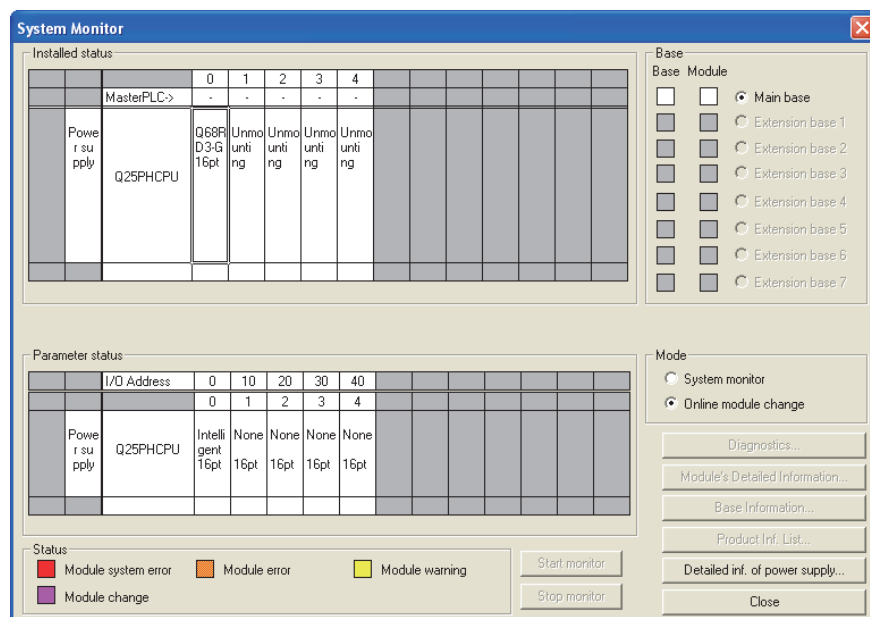

(b) Click the **Execution** button to enable a module change.

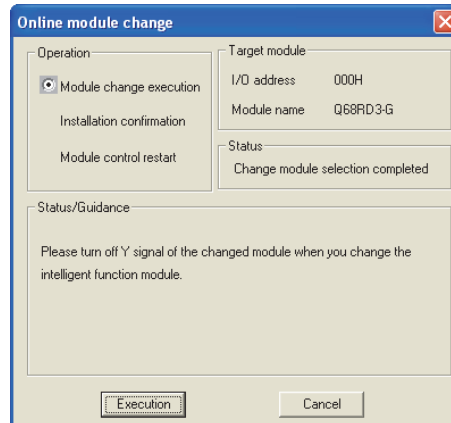

If the following screen appears, the user range setting cannot be saved.

Click the **OK** button, and perform the operation in Section 7.3.4 (2)(c) and later.

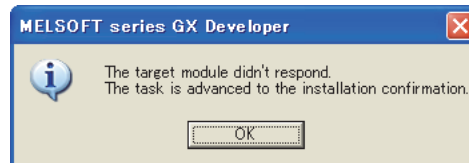

(c) After confirming that the "RUN" LED of the module has turned off, disconnect the connector and remove the module.

POINT

Make sure to remove the module. If the mounting status is confirmed ("Installation confirmation" is executed) without removing the module, the module will not start properly and the "RUN" LED will not turn on.

(3) Mounting a new module

- (a) Mount the removed module and a new module to a separate system.
- (b) Using the G(P).OGLOAD instruction, save the user range setting values to the CPU device. For the G(P).OGLOAD instruction, refer to Appendix 1.3.
- (c) Using the G(P).OGSTOR instruction, restore the user range setting values to the module. For the G(P).OGSTOR instruction, refer to Appendix 1.4.
- (d) Remove the new module from the separate system, mount it to the slot from where the old module was removed in the original system, and connect the connector.
- (e) After mounting the module, click the **Execution** button and confirm that the "RUN" LED is on. Module ready (X0) remains OFF.

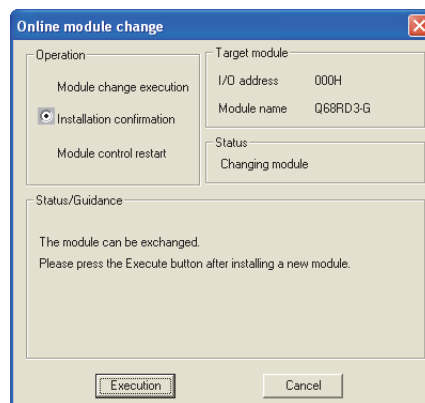

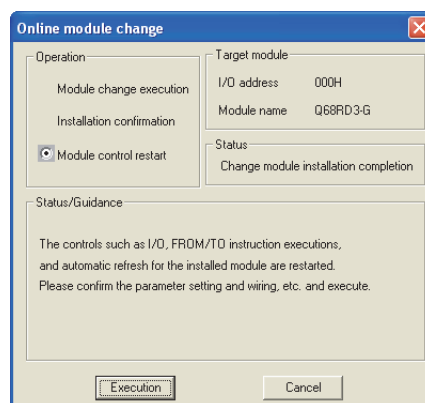

(4) Checking operation

- (a) For checking operation, click the **Cancel** button to cancel the restart of control to the module.

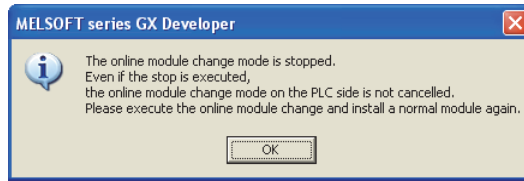

- (b) Click the  button to leave the "Online module change" mode.



- (c) Click the  button to close the "System monitor" screen.

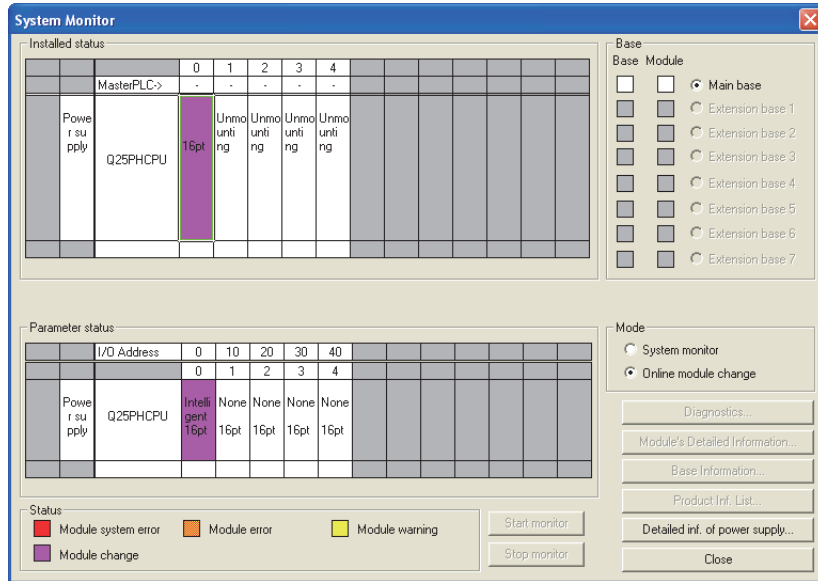

- (d) Monitor the CH1 Measured temperature value (Un\G11 to Un\G18) to check that conversion has been made properly.

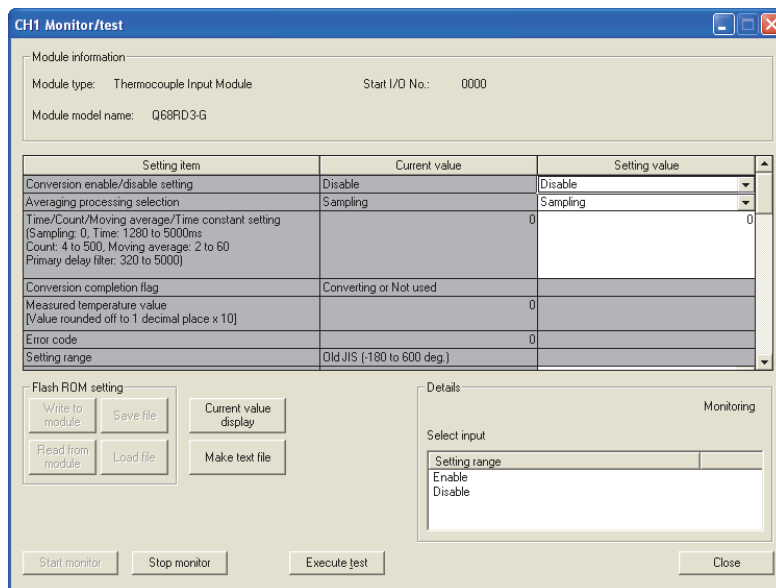

(5) Restarting control

(a) Display the "Online module change" screen again from the screen displayed by selecting [Diagnosis] - [Online module change] in GX Developer and click the

 Execution button to restart control. Module ready (X0) turns on.

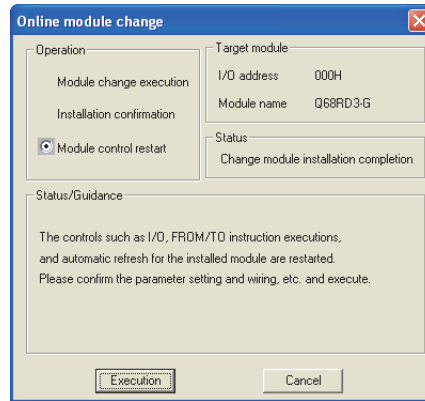

(b) The following screen appears.



7.3.4 When user range setting is used and initial setting has been made with GX Configurator-TI (Separate system is not available)

(1) Disabling conversion

- (a) Set "Disable" in the Setting value field of "Conversion enable/disable setting" on the "CH \square Monitor/test" screen in GX Configurator-TI, and click the  button.

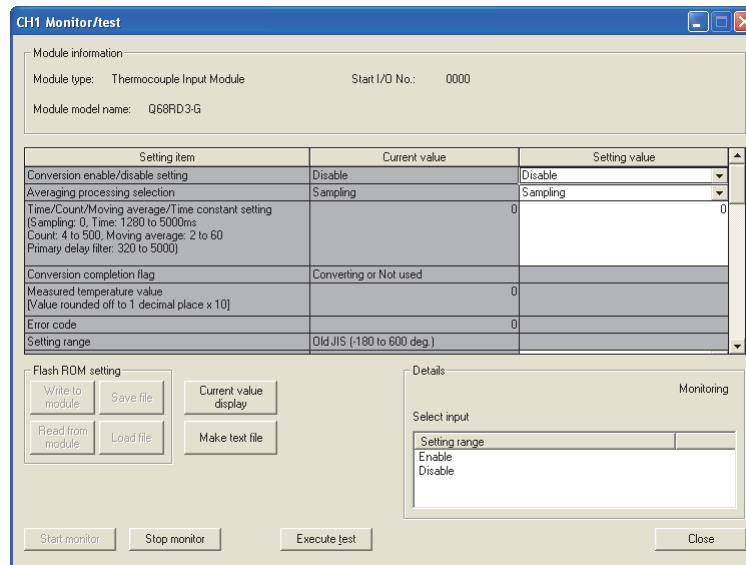

- (b) Confirm that the Current value field of "Conversion enable/eisable setting" has been changed to "Disable", and then select "Request" in the Setting value field of "Operation condition setting request" on the "Monitor/test" screen and click the  button to stop conversion. Monitor the Conversion completion flag (Un\G10) and confirm that conversion has stopped.

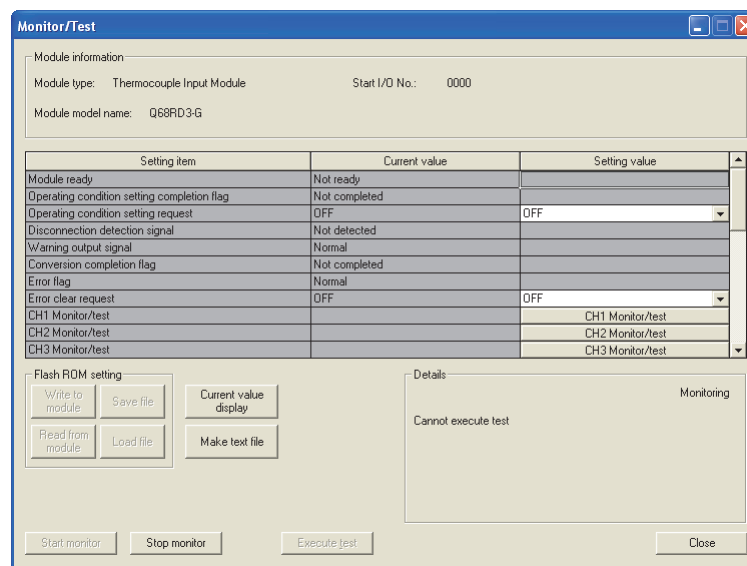

- (c) If the save target buffer memory data have not been taken down yet, take them down in the following procedure.
- 1) Display the "OMC (Online Module Change) refresh data" screen of GX Configurator-TI.
 - 2) Execute a OMC refresh data read request. (Refer to Section 5.6.3.)
 - 3) Compare the values in the Current value field of the following items with those in the range reference table and confirm that values are appropriate.
For the range reference table, refer to Section 7.4.
 - CH Factory default offset value
 - CH Factory default gain value
 - CH User range settings offset value
 - CH User range settings gain value
 - CH User range settings resistance offset value
 - CH User range settings resistance gain value
 - 4) Take a note of the current values of OMC refresh data.

POINT

If the buffer memory values compared with the range reference table are not appropriate, the user range setting values cannot be saved/restored. Perform offset/gain setting using GX Configurator-TI before restarting control of the module. (Refer to Section 5.6.2.)
Note that if module control is restarted without setting the offset/gain setting values, the module will operate with the default values.

(2) Removing a module

- (a) On the screen displayed by selecting [Diagnosis] - [Online module change] in GX Developer, select the "Online module change" mode and double-click the module to be changed online to display the "Online module change" screen.

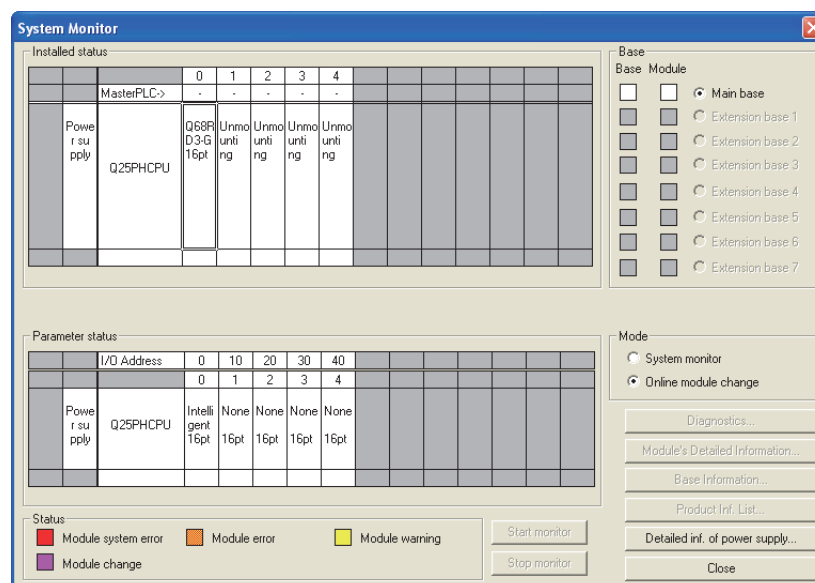

- (b) Click the **Execution** button to enable a module change.

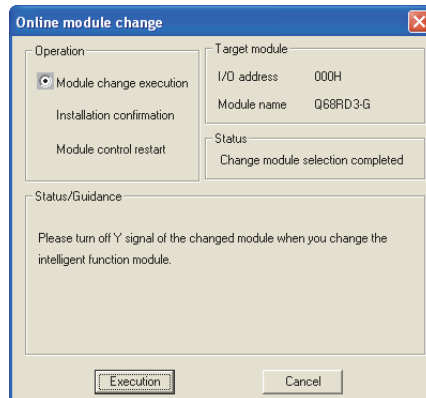

If the following screen appears, the user range setting cannot be saved.

Click the **OK** button, and perform the operation in (2)(c) in this section and later.

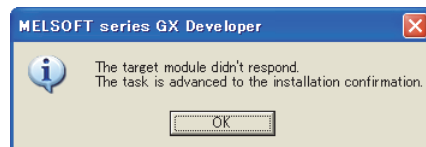

- (c) After confirming that the "RUN" LED of the module has turned off, disconnect the connector and remove the module.

POINT

Make sure to remove the module. If the mounting status is confirmed ("Installation confirmation" is executed) without removing the module, the module will not start properly and the "RUN" LED will not turn on.

(3) Mounting a new module

- (a) Mount a new module to the same slot and connect the connector.
- (b) After mounting the module, click the **Execution** button and confirm that the "RUN" LED is on. Module ready (X0) remains OFF.

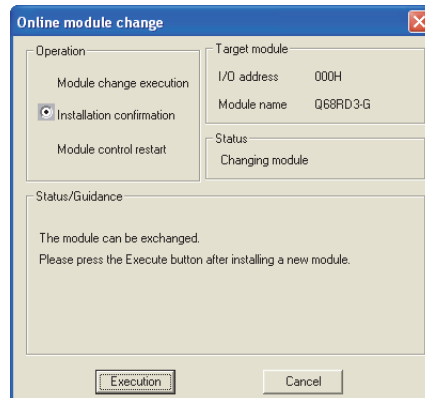

(4) Checking operation

- (a) For checking operation, click the **Cancel** button to cancel the restart of control to the module.

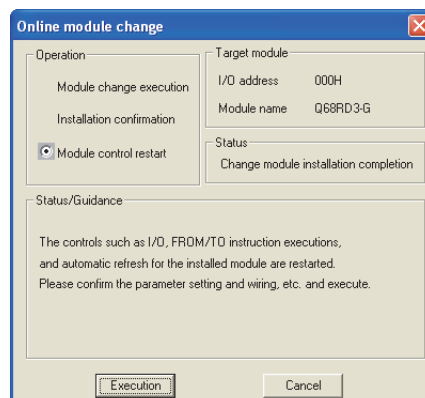

- (b) Click the **OK** button to leave the "Online module change" mode.

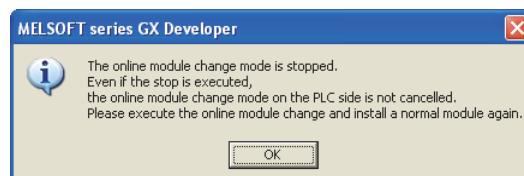

(c) Click the button to close the "System monitor" screen.

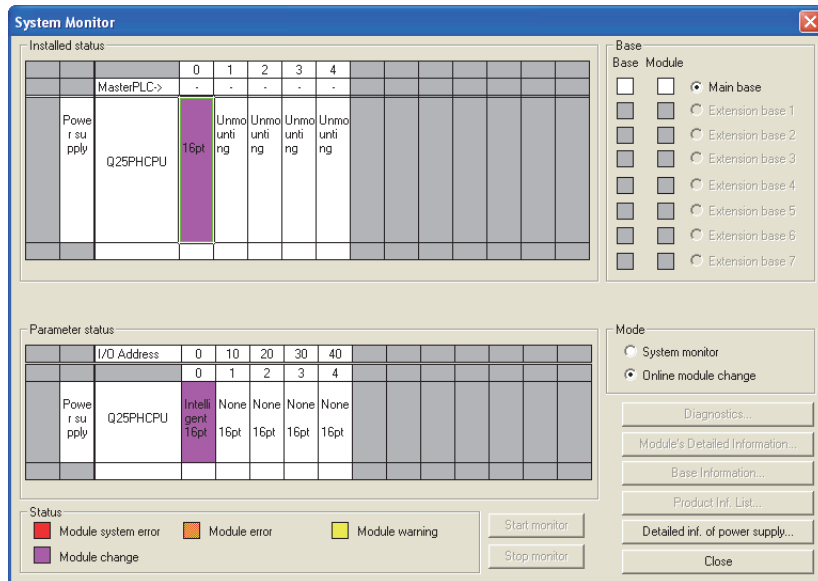

(d) Set the noted values on the "OMC (Online Module Change) refresh data" screen of GX Configurator-TI and execute a OMC refresh data write request. (Refer to Section 5.6.3.)

(e) Monitor the CH \square Measured temperature value (Un\G11 to Un\G18) to check that conversion has been made properly.

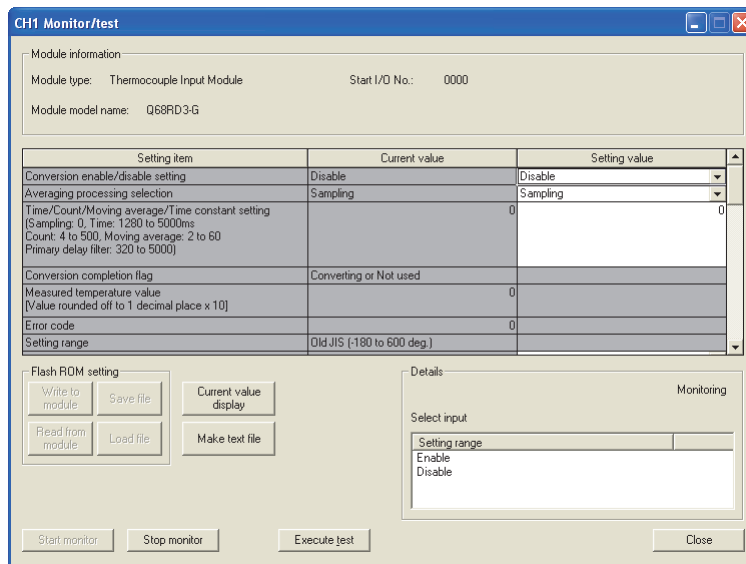

(5) Restarting control

(a) Display the "Online module change" screen again from the screen displayed by selecting [Diagnosis] - [Online module change] in GX Developer and click the

 button to restart control. Module ready (X0) turns on.

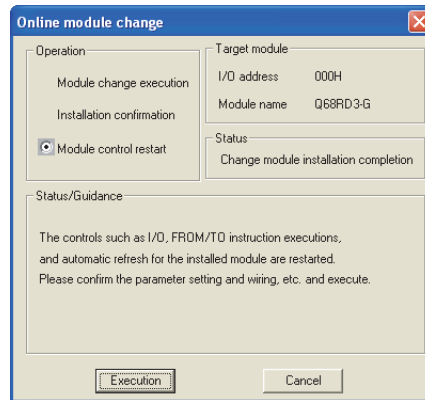

(b) The following screen appears.



7.3.5 When user range setting is used and initial setting has been made with sequence program (Separate system is available)

(1) Disabling conversion

- (a) Set the Conversion enable/disable setting (Un\G0) to "Disable" for all channels and turn Operating condition setting request (Y9) from OFF to ON to stop conversion.
After confirming that conversion has stopped with the Conversion completion flag (Un\G10), turn OFF Operating condition setting request (Y9).

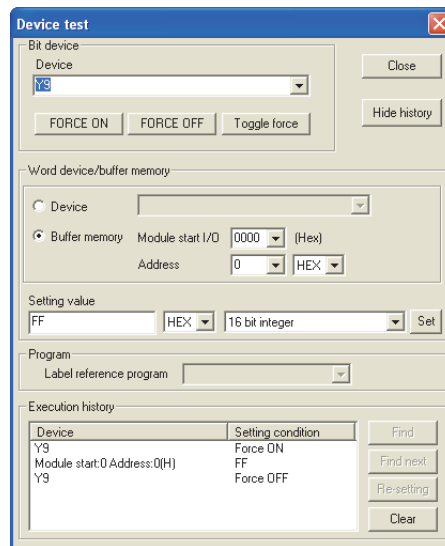

(2) Removing a module

- (a) On the screen displayed by selecting [Diagnosis] - [Online module change] in GX Developer, select the "Online module change" mode and double-click the module to be changed online to display the "Online module change" screen.

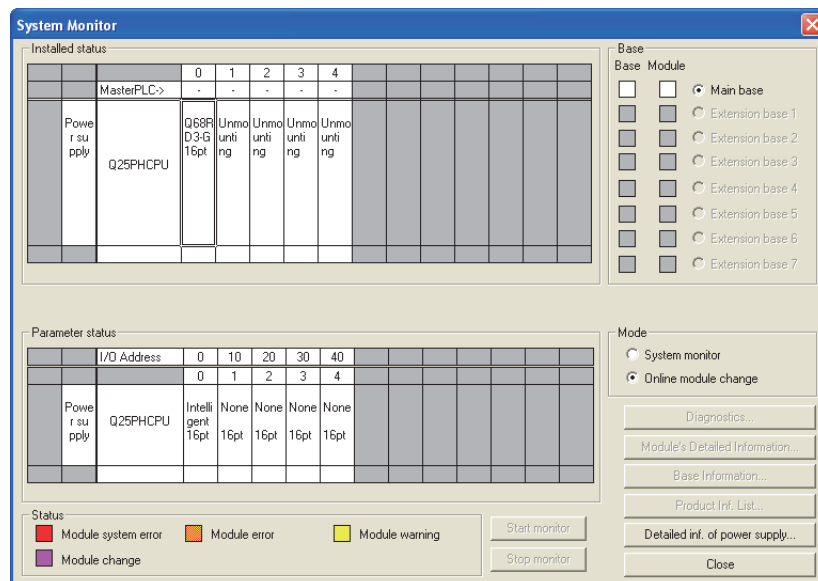

(b) Click the **Execution** button to enable a module change.

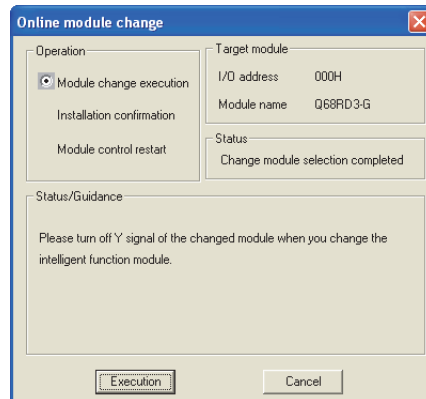

If the following screen appears, the user range setting cannot be saved.

Click the **OK** button, and perform the operation in Section 7.3.6 (2)(c) and later.

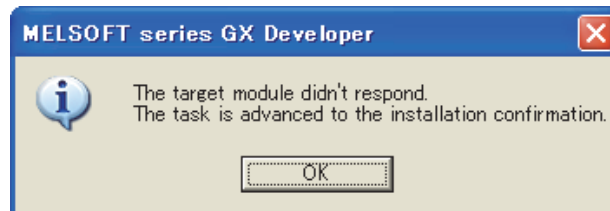

(c) After confirming that the "RUN" LED of the module has turned off, disconnect the connector and remove the module.

POINT

Make sure to remove the module. If the mounting status is confirmed ("Installation confirmation" is executed) without removing the module, the module will not start properly and the "RUN" LED will not turn on.

(3) Mounting a new module

- (a) Mount the removed module and a new module to a separate system.
- (b) Using the G(P).OGLOAD instruction, save the user range setting values to the CPU device. For the G(P).OGLOAD instruction, refer to Appendix 1.3.
- (c) Using the G(P).OGSTOR instruction, restore the user range setting values to the module. For the G(P).OGSTOR instruction, refer to Appendix 1.4.
- (d) Remove the new module from the separate system, mount it to the slot from where the old module was removed in the original system, and connect the connector.
- (e) After mounting the module, click the **Execution** button and confirm that the "RUN" LED is on. Module ready (X0) remains OFF.

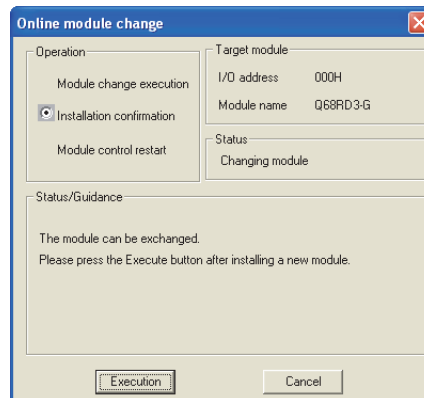

(4) Checking operation

- (a) For checking operation, click the **Cancel** button to cancel the restart of control to the module.

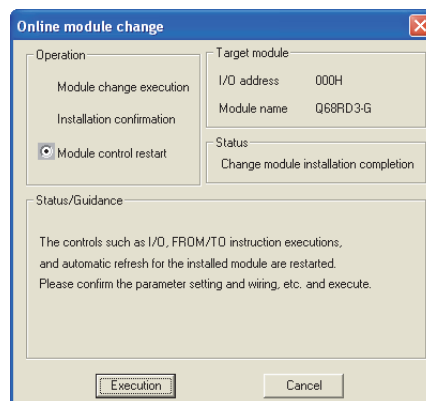

- (b) Click the **OK** button to leave the "Online module change" mode.

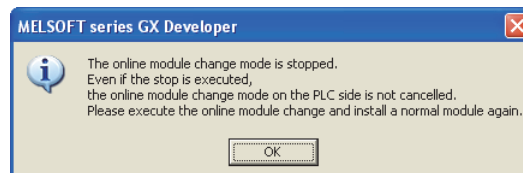

- (c) Click the button to close the "System monitor" screen.

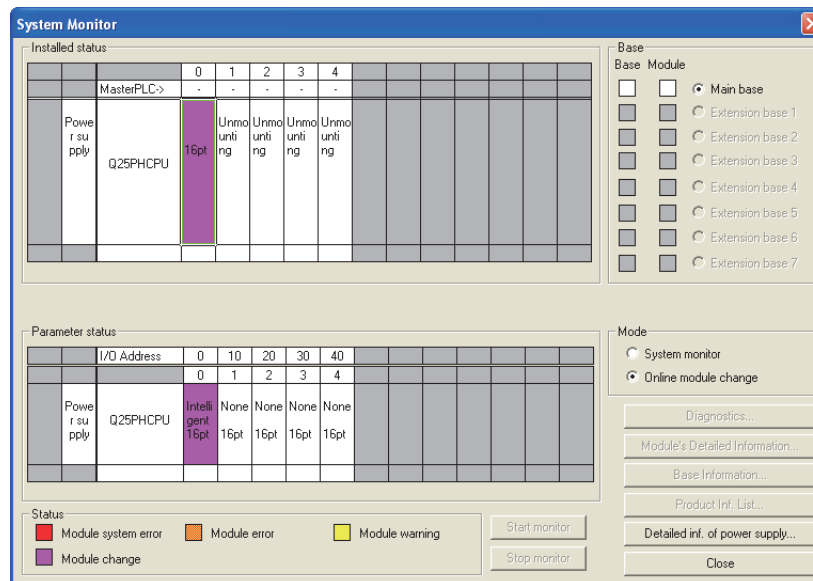

- (d) Enable the conversion of the channel to be used in Conversion enable/disable setting (Un\G0), and turn Operating condition setting request (Y9) from OFF to ON. Monitor CH□ Measured temperature value (Un\G11 to Un\G18) to check if the conversion is processed normally.
- (e) Since the new module is in a default state, initial setting must be performed by a sequence program after the restart of control. Before performing initial setting, check that the contents of an initial setting program are correct.
- 1) When a module is used in normal system configuration
 - Create a sequence program so that initial setting is performed on the rising edge of Module ready (X9) of the Q68RD3-G.
 - When control is restarted, Module ready (X0) turns ON and initial setting is performed. (If the sequence program performs initial setting only for one scan after RUN, initial setting will not be performed.)
 - 2) When a module is used on remote I/O network
 - Insert a user device that will perform initial setting at any timing (Initial setting request signal) into a sequence program. After the restart of control, turn ON Initial setting request signal to perform initial setting. (If the sequence program performs initial setting only for one scan after a data link start of the remote I/O network, initial setting will not be performed.)

(5) Restarting control

- (a) Display the "Online module change" screen again from the screen displayed by selecting [Diagnosis] - [Online module change] in GX Developer and click the

 button to restart control. Module ready (X0) turns on.

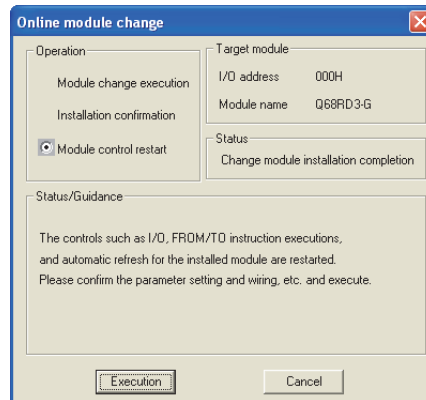

- (b) The following screen appears.



7.3.6 When user range setting is used and initial setting has been made with sequence program (Separate system is not available)

(1) Disabling conversion

- (a) Set the Conversion enable/disable setting (Un\G0) to "Disable" for all channels and turn Operating condition setting request (Y9) from OFF to ON to stop conversion.

After confirming that conversion has stopped with the Conversion completion flag (Un\G10), turn OFF Operating condition setting request (Y9).

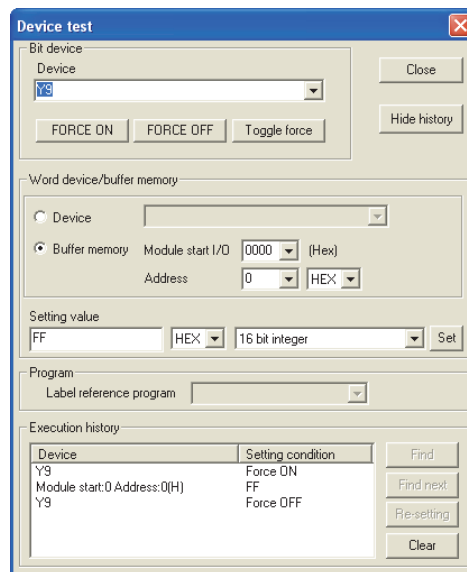

- (b) If the save target buffer memory data have not been taken down yet, take them down in the following procedure.

- 1) Turn Operating condition setting request (Y9) form OFF to ON.
- 2) Compare the following buffer memory values with those in the range reference table and confirm that values are appropriate.

For the range reference table, refer to Section 7.4.

- CH□ Factory default offset value (Un\G190^{*1})
- CH□ Factory default gain value (Un\G191^{*1})
- CH□ User range settings offset value (Un\G192^{*1})
- CH□ User range settings gain value (Un\G193^{*1})
- CH□ User range settings resistance offset value (Un\G194, Un\G195^{*1})
- CH□ User range settings resistance gain value (Un\G196, Un\G197^{*1})

* 1 Only the buffer memory address of CH1 is shown.

For buffer memory addresses of other channels, refer to the Section 3.4.1 "Buffer memory assignment".

- 3) Take a note of the buffer memory values.

POINT

If the buffer memory values compared with the range reference table are not appropriate, the user range setting values cannot be saved/restored. Before restarting control to the module, perform offset/gain setting using "Device test" of GX Developer, following the flowchart in Section 4.6. Switch the mode using the setting of the Mode switching setting (Un\G158 and Un\G159) and turning Operating condition setting request (Y9) from OFF to ON. Note that if module control is restarted without setting the offset/gain setting values, the module will operate with the default values.

(2) Removing a module

- (a) On the screen displayed by selecting [Diagnosis] - [Online module change] in GX Developer, select the "Online module change" mode and double-click the module to be changed online to display the "Online module change" screen.

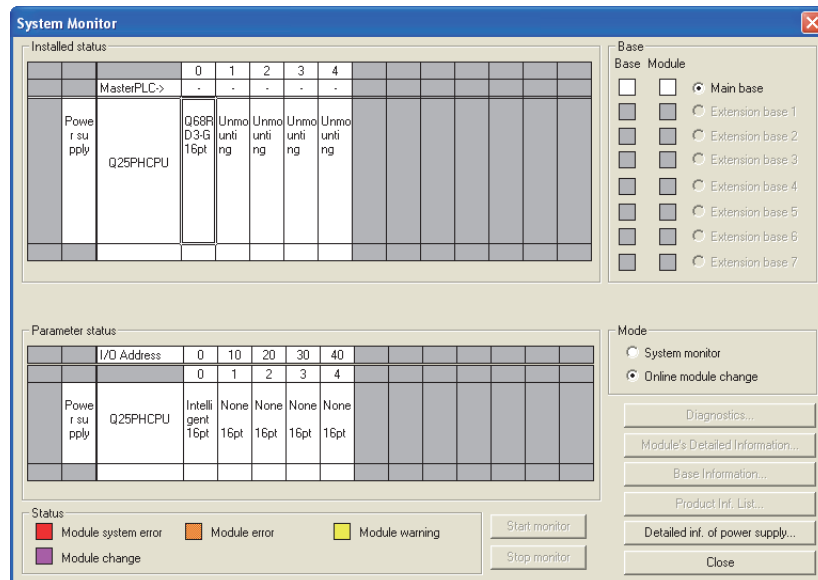

- (b) Click the **Execution** button to enable a module change.

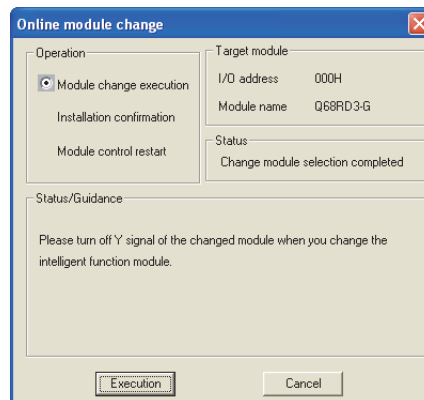

If the following screen appears, the user range setting cannot be saved.

Click the **OK** button, and perform the operation in (2)(c) in this section and later.

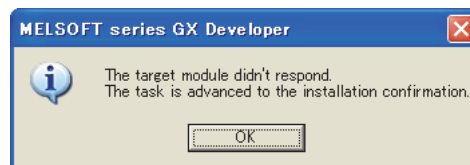

- (c) After confirming that the "RUN" LED of the module has turned off, disconnect the connector and remove the module.

POINT

Make sure to remove the module. If the mounting status is confirmed ("Installation confirmation" is executed) without removing the module, the module will not start properly and the "RUN" LED will not turn on.

(3) Mounting a new module

- (a) Mount a new module to the same slot and connect the connector.
- (b) After mounting the module, click the **Execution** button and confirm that the "RUN" LED is on. Module ready (X0) remains OFF.

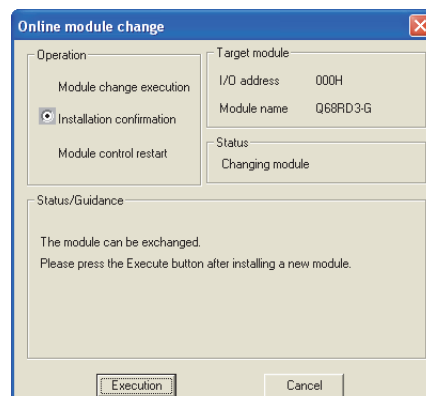

(4) Checking operation

- (a) For checking operation, click the button to cancel the restart of control to the module.

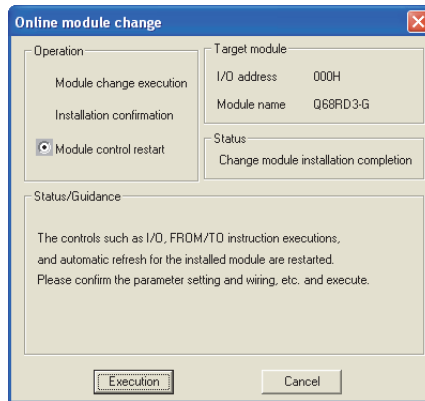

- (b) Click the button to leave the "Online module change" mode.

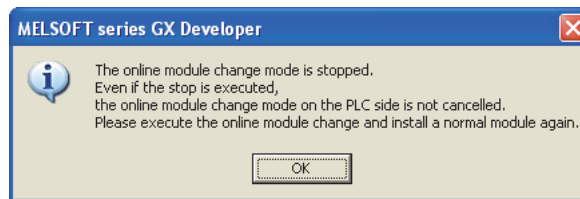

- (c) Click the button to close the "System monitor" screen.

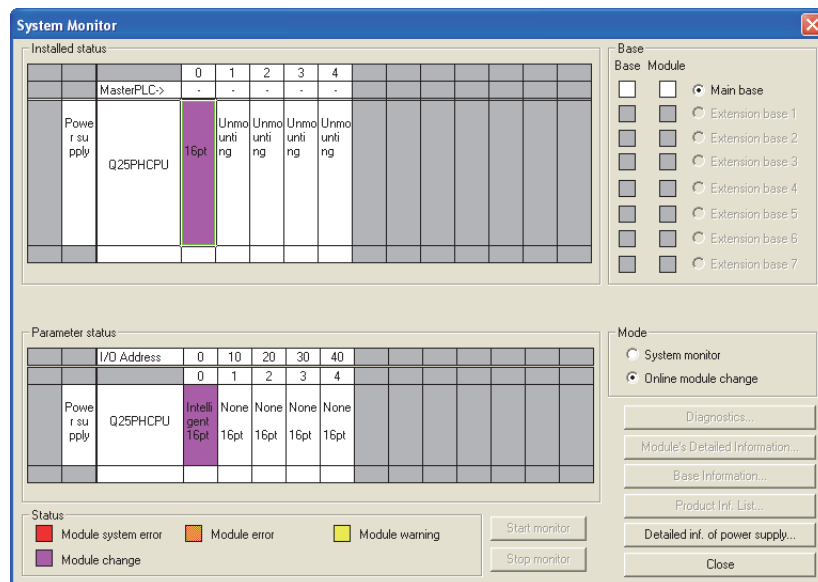

- (d) Set the noted values to the buffer memory on the screen displayed by selecting [Online] - [Debug] - [Device test] in GX Developer.
- (e) Turn User range write request (YA) from OFF to ON to restore the user range setting values to the module.
After confirming that Offset/gain setting mode status flag (XA) is ON, turn OFF User range write request (YA).

- (f) Enable the conversion of the channel to be used in Conversion enable/disable setting (Un\G0), and turn Operating condition setting request (Y9) from OFF to ON. Monitor CH□ Measured temperature value (Un\G11 to Un\G18) to check if the conversion is processed normally.
- (g) Since the new module is in a default state, initial setting must be performed by a sequence program after the restart of control.
Before performing initial setting, check that the contents of an initial setting program are correct.
 - 1) When a module is used in normal system configuration
Create a sequence program so that initial setting is performed on the rising edge of Module ready (X9) of the Q68RD3-G.
When control is restarted, Module ready (X0) turns ON and initial setting is performed. (If the sequence program performs initial setting only for one scan after RUN, initial setting will not be performed.)
 - 2) When a module is used on remote I/O network
Insert a user device that will perform initial setting at any timing (Initial setting request signal) into a sequence program. After the restart of control, turn ON Initial setting request signal to perform initial setting. (If the sequence program performs initial setting only for one scan after a data link start of the remote I/O network, initial setting will not be performed.)

(5) Restarting control

- (a) Display the "Online module change" screen again from the screen displayed by selecting [Diagnosis] - [Online module change] in GX Developer and click the  button to restart control. Module ready (X0) turns on.

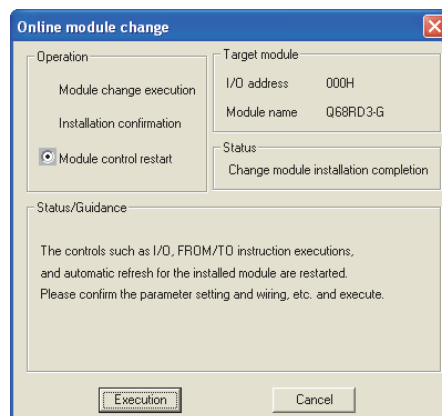

- (b) The following screen appears.



7.4 Range Reference Table

The range reference table is given below.

Table 7.3 Range reference table

Address (Decimal)								Description	Reference value
CH1	CH2	CH3	CH4	CH5	CH6	CH7	CH8		
190	198	206	214	222	230	238	246	Factory default offset value	Digital value for offset value set prior to shipment (Reference value 1DDBH)
191	199	207	215	223	231	239	247	Factory default gain value	Digital value for gain value set prior to shipment (Reference value 58A7H)
192	200	208	216	224	232	240	248	User range settings offset value	Digital value for user-set offset value (Refer to (3) in this section.)
193	201	209	217	225	233	241	249	User range settings gain value	Digital value for user-set gain value (Refer to (4) in this section.)
194, 195	202, 203	210, 211	218, 219	226, 227	234, 235	242, 243	250, 251	User range settings resistance offset value ($\times 10^{-3}\Omega$)	Resistance value for user-set offset setting temperature ($\times 10^{-3}\Omega$) (Refer to (5) in this section.)
196, 197	204, 205	212, 213	220, 221	228, 229	236, 237	244, 245	252, 253	User range settings resistance gain value ($\times 10^{-3}\Omega$)	Resistance value for user-set gain setting temperature ($\times 10^{-3}\Omega$) (Refer to (6) in this section.)

- (1) Compare the Factory default offset value with the reference value 1DDBH.
- (2) Compare the Factory default gain value with the reference value 58A7H.
- (3) Compare the User range settings offset value with the value obtained from the following expression.

$$(\text{Digital value}) = \left\{ \left(\left[\begin{array}{l} \text{User range settings resistance} \\ \text{offset value } (\times 10^{-3}\Omega) \end{array} \right] - 100000 \right) \times \left(\frac{15052}{197160} \right) \right\} + 7643$$
- (4) Compare the User range settings gain value with the value obtained from the following expression.

$$(\text{Digital value}) = \left\{ \left(\left[\begin{array}{l} \text{User range settings resistance} \\ \text{gain value } (\times 10^{-3}\Omega) \end{array} \right] - 100000 \right) \times \left(\frac{15052}{197160} \right) \right\} + 7643$$
- (5) Compare the User range settings resistance offset value with a value obtained by (a) and (b) below.
 - (a) Obtain a reference resistance value that corresponds to the offset setting temperature set by the user from the chart of RTD's reference resistance value (RTDs compliant with JIS C 1604-1997 or IEC 751 1983, JIS C 1604-1981, or DIN 43760 1987).
 - (b) Multiply the reference resistance value obtained in the step (a) by 1000.

(6) Compare the User range settings resistance gain value with a value obtained by (a) and (b) below.

- (a) Obtain a reference resistance value that corresponds to the gain setting temperature set by the user from the chart of RTD's reference resistance values (RTDs compliant with JIS C 1604-1997 or IEC 751 1983, JIS C 1604-1981, or DIN 43760 1987).
- (b) Multiply the reference resistance value obtained in the step (a) by 1000.

 POINT

The chart of RTD's reference resistance values (RTDs compliant with JIS C 1604-1997 or IEC 751 1983, JIS C 1604-1981, or DIN 43760 1987) needs to be arranged by the user.

(Example)

When offset/gain setting is performed, setting the offset setting temperature at -200.0°C and the gain setting temperature at 850.0°C, with a Pt100 platinum RTD connected

Table 7.4 How to obtain reference value

Value type	Setting temperature	Reference value of User range settings resistance offset/gain values	Reference value of User range settings offset/gain values
Offset value	-200.0°C	18520 ($\times 10^{-3}\Omega$)	$(18520 - 100000) \times \left(\frac{15052}{197160}\right) + 7643 = 1422 \rightarrow 058EH$
Gain value	850.0°C	390480 ($\times 10^{-3}\Omega$)	$(390480 - 100000) \times \left(\frac{15052}{197160}\right) + 7643 = 29819 \rightarrow 747BH$

7.5 Precautions for Online Module Change

This section describes the precautions for online module change.

- (1) Follow proper procedures when performing online module change. Failure to do so can cause a malfunction or failure of the module.**
- (2) If online module change is performed with the user range setting, the accuracy after changing the module will fall to about less than 1/3 of the accuracy before that.
Re-set the offset/gain values as necessary.**
- (3) During an online module change, do not perform the operations below. If they are performed, the Q68RD3-G may not operate normally.**
 - (a) Powering off the programmable controller CPU
 - (b) Resetting the programmable controller CPU

CHAPTER8 TROUBLESHOOTING

This chapter describes the errors which may occur during the use of the Q68RD3-G and troubleshooting.

8.1 Error Code List

If an error occurs when data is written to/read from the programmable controller CPU, the Q68RD3-G writes the corresponding error code to the buffer memory address (Un\G19). Errors are classified into two levels: moderate (module error) and minor (module warning). When a moderate error occurs, conversion processing is not performed. When a minor error occurs, conversion processing is performed with the settings that the system operated normally last time.

Table 8.1 Error code list (1/2)

Error code (Decimal)	Error level	Description	Corrective action
10□	Moderate	A value other than "0 _H " to "5 _H ", or "8 _H " is set to the measurement range setting in the intelligent function module switch setting. □ indicates the error channel number.	Set a correct parameter value in the parameter setting of GX Developer. (Refer to Section 4.5.)
111	Moderate	A hardware error of the module	Turn the power supply OFF, then ON again. If the same error occurs, the module may have failed. Please consult your local Mitsubishi representative.
112	Moderate	The setting value of the intelligent function module switch 5 is other than "0".	Set "0" for the intelligent function module switch 5 in the parameter setting of GX Developer. (Refer to Section 4.5.)
120* ¹	Moderate	An invalid value is set in the offset/gain setting. The error channel number cannot be identified.	Perform the offset/gain setting again for all of the channels that use the user range setting. If the same error occurs, the module may have failed. Please consult your local Mitsubishi representative.
12□* ¹	Moderate	An invalid value is set in the offset/gain setting. □ indicates the error channel number.	Perform the offset/gain setting again for the error channel. If the same error occurs, the module may have failed. Please consult your local Mitsubishi representative.
161* ²	Minor	The G(P).OGSTOR instruction was executed in the offset/gain setting mode.	Do not execute the G(P).OGSTOR instruction in the offset/gain setting mode.
162* ¹	Minor	•The G(P).OGSTOR instruction was executed consecutively. •At the time of offset/gain setting, setting values were written to the flash memory 26 times or more.	•Execute the G(P).OGSTOR instruction only once per module. •At the time of offset/gain setting, write setting values only once at a time.
163* ¹	Minor	•The G(P).OGSTOR instruction was executed for the model that differs from the model for which the G(P).OGLOAD instruction had been executed. •The G(P).OGSTOR instruction had been executed before the G(P).OGLOAD instruction was executed.	•Execute the G(P).OGLOAD and G(P).OGSTOR instructions for the same model. •Execute the G(P).OGLOAD instruction first, then G(P).OGSTOR instruction.
20□* ¹	Minor	The average time setting value set in Un\G1 to Un\G8 is outside the range of 1280 to 5000ms. □ indicates the error channel number.	Re-set the average time setting value within the range of 1280 to 5000ms.
30□* ¹	Minor	The average count setting value set in Un\G1 to Un\G8 is outside the range of 4 to 500 times. □ indicates the error channel number.	Re-set the average count setting value within the range of 4 to 500 times.

Table 8.1 Error code list (2/2)

Error code (Decimal)	Error level	Description	Corrective action
31□*1	Minor	The moving average count setting value set in Un\G1 to Un\G8 is outside the range of 2 to 60 times. □ indicates the error channel number.	Re-set the moving average count setting value within the range of 2 to 60 times.
32□*1	Minor	The time constant setting value for the primary delay filter set in Un\G1 to Un\G8 is outside the range of 320 to 5000ms. □ indicates the error channel number.	Re-set the time constant setting value within the range of 320 to 5000ms.
40□*1	Minor	(Gain value) - (Offset value) ≤ 0.1 [°C] □ indicates the error channel number.	Check the resistance value at the RTD input terminal.
41□*1	Minor	(Gain temperature setting value) - (Offset temperature setting value) ≤ 0.1 [°C] □ indicates the error channel number.	Re-set the Offset/gain temperature setting value (Un\G28 to Un\G43) for the error channel.
500*1	Minor	The offset/gain channels were set at the same time during the offset/gain setting, or both were set to "0".	Re-set the values for the Offset/gain setting mode (Offset specification) (Un\G26) and the Offset/gain setting mode (Gain specification) (Un\G27).
51□*1	Minor	When Channel change request (YB) is turned ON, the setting status is either of the following. •The offset temperature setting value or gain temperature setting value of the specified channel is set outside the measurement range. •The disconnected or conversion-disabled channel is specified. □ indicates the error channel number.	•Check the measurement range and re-set the Offset/gain temperature setting values (Un\G28 to Un\G43) within the range. •Check the wiring status or specify the conversion-enabled channel.
6△□*1	Minor	The Process alarm upper/lower limit values (Un\G94 to Un\G125) are set contradictorily. □ indicates the error channel number. △ indicates the following status. 0: The lower lower limit value is lower than the measurement range. 1: The upper upper limit value is higher than the measurement range. 2: (Lower lower limit value) > (Lower upper limit value) 3: (Lower upper limit value) > (Upper lower limit value) 4: (Upper lower limit value) > (Upper upper limit value)	Re-set the Process alarm upper/lower limit values (Un\G94 to Un\G125).
70□*1	Minor	The Rate alarm warning detection period (Un\G126 to Un\G133) is outside the range of 1 to 6000 times □ indicates the error channel number.	Re-set the Rate alarm warning detection period (Un\G126 to Un\G133) within the range of 1 to 6000 times.
91□*1	Minor	The setting values of the Scaling range upper/lower limit values (Un\G62 to Un\G77) or the Scaling width upper/lower limit values (Un\G78 to Un\G93) are set to (Lower limit) = (Upper limit). □ indicates the error channel number.	Re-set the Scaling range upper/lower limit values (Un\G62 to Un\G77) or the Scaling width upper/lower limit values (Un\G78 to Un\G93).

POINT

- (1) The latest error code detected by the Q68RD3-G is stored when two or more errors occur.
- (2) The error codes marked with *1 can be cleared by turning ON the error clear request (YF).
- (3) The error code: 161 marked *2 can not be stored in the Error code (Un\G19). It is stored in the completion status area (S)+1 of the G(P).OGSTOR instruction.

8.2 Troubleshooting

8.2.1 When "RUN" LED turns off

Table 8.2 When "RUN" LED turns off

Check Item	Corrective action
Is power supplied?	Check that the supply voltage of the power supply module is within the rated range.
Is the capacity of the power supply module sufficient?	Calculate the current consumption of the CPU, I/O, intelligent function and other modules mounted on the base unit, and make sure that the capacity of the power supply module is enough.
Has a watchdog timer error occurred?	Reset the programmable controller CPU and check that the "RUN" LED turns on. If the "RUN" LED does not turn on, the module may have failed. Please consult your local Mitsubishi representative.
Are the modules mounted correctly on the base unit?	Check the module mounting status.
Is the module in the online module change enable status?	Refer to CHAPTER 7 and take corrective action.

8.2.2 When "RUN" LED flashes

Table 8.3 When "RUN" LED flashes

Check Item	Corrective action
Is the module in the offset/gain setting mode?	Re-set the intelligent function module switch 4 in GX Developer to the normal mode. (Refer to Section 4.5.)

8.2.3 When "ERR" LED flashes

Table 8.4 When "ERR" LED flashes

Check Item	Corrective action
Is the setting value of the intelligent function module switch 5 other than "0"?	Set "0" for the intelligent function module switch 5 in GX Developer. (Refer to Section 4.5.)

8.2.4 When "ERR" LED turns on

Table 8.5 When "ERR" LED turns on

Check Item	Corrective action
Has an error occurred?	Check the error code and take the corrective action given in Section 8.1.

8.2.5 When "ALM" LED flashes

Table 8.6 When "ALM" LED flashes

Check Item	Corrective action
Is the wire connected properly (not disconnected)?	Check the Disconnection detection flag (Un\G49) and take the corrective action given in Section 8.2.7.

8.2.6 When "ALM" LED turns on

Table 8.7 When "ALM" LED turns on

Check Item	Corrective action
Has a warning output occurred?	Check the Warning output flag (Un\G47 and Un\G48).

8.2.7 When Disconnection detection signal (XC) turns ON

Table 8.8 When Disconnection detection signal (XC) turns ON

Check Item	Corrective action
Is the RTD connected correctly?	Connect the RTD correctly.
Is the wire connected to the RTD not disconnected?	Check the conductive status of the connected RTD and replace the disconnected RTD.
Is the channel where no RTD is connected set to "conversion enable"?	Check the conversion-enable channels and the channels where RTD is connected, and set the conversion enable/disable setting correctly.

8.2.8 When measured temperature value cannot be read

Table 8.9 When measured temperature value cannot be read

Check Item	Corrective action
Is the Conversion enable/disable setting (Un\ G0) of the channel to be used set to "conversion disable"?	Set the Conversion enable/disable setting (Un\ G0) of the channel to be used for "conversion enable" using a sequence program or GX Configurator-TI.
Is the programmable controller CPU set for STOP?	Set the programmable controller CPU for RUN.

8.2.9 When measured temperature value is abnormal

Table 8.10 When measured temperature value is abnormal

Check Item	Corrective action
Is the type of connected RTD the same as in the setting?	Set the connected RTD type to the intelligent function module switch 1 and 2 using GX Developer.
Is the RTD connected correctly (not reversely)?	Connect the RTD correctly.
Has the RTD input affected by noise?	Check influence from the ground and adjacent devices, and take action to prevent noise.
Is different RTD connected after setting the offset/gain values?	Set the offset/gain setting values again using the RTD changed.
Is wiring between the module and terminal block correct?	Check that wiring between the module and terminal block is correct.

☒ POINT

The module may have failed if the measured temperature value cannot be read after proper corrective actions have been taken according to the above check items. Please consult your local Mitsubishi representative.

8.2.10 Checking Q68RD3-G status using system monitor of GX Developer

The detailed information of the Q68RD3-G, error code and LED status, can be checked from the "System monitor" screen in GX Developer.

(1) GX Developer operation

[Diagnostics] → [System monitor] → Select "Q68RD3-G" → Module's Detailed Information...

(2) Module's Detailed Information

(a) Checking function version and product information

The function version and product information of the Q68RD3-G is displayed in the Product information field.

(b) Checking error code

The error code stored in the Error code (Un\G19) of the Q68RD3-G is displayed in the Present Error field.

(When the Error History button is clicked, the contents displayed in the Present Error field are displayed in the No. 1 field.)

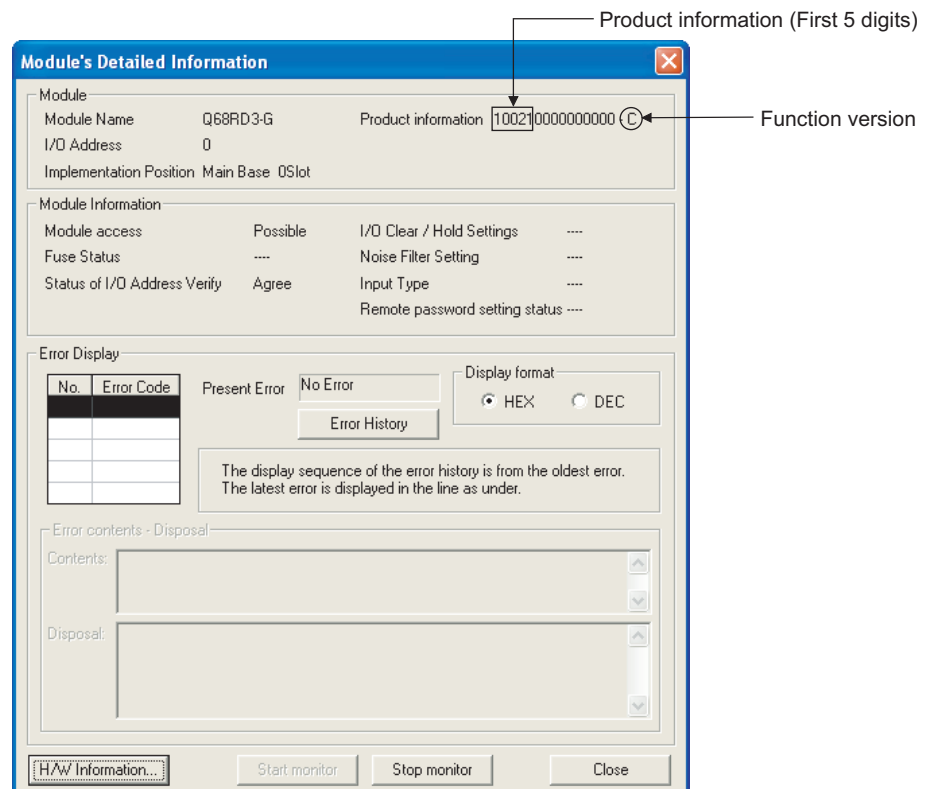

(3) H/W Information

Use GX Developer Version 8.68W or later to check the H/W information.

(a) H/W LED Information

The LED status is displayed.

Table 8.11 LED status

Item	Status
RUN LED	0000H: Indicates that LED is off.
ERR. LED	0001H: Indicates that LED is on.
ALM LED	Alternate indication between 0000H and 0001H: Indicates that LED is flashing.

(b) H/W SW Information

The status of the intelligent function module switch setting is displayed.

Table 8.12 Intelligent function module switch setting status

Item	Intelligent function module switch setting	Reference
RANGE1	Switch 1: Measurement range setting (CH1 to CH4)	Section 4.5
RANGE2	Switch 2: Measurement range setting (CH5 to CH8)	
RANGE3	Switch 3: Offset/gain setting	
MODE	Switch 4: Mode setting	
—	Switch 5: —	

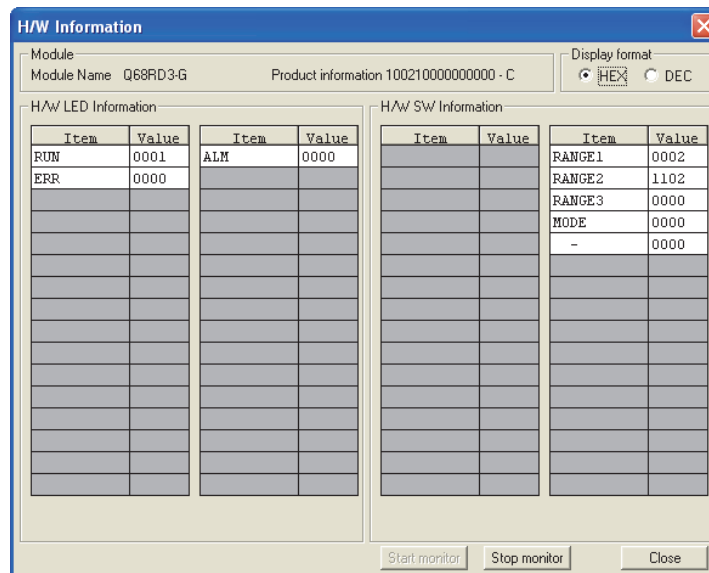

APPENDICES

Appendix 1 Dedicated Instructions

Appendix 1.1 List of Dedicated Instructions and Available Devices

(1) List of dedicated instructions

The following table lists the dedicated instructions that can be used for the Q68RD3-G.

Table APPX.1 List of dedicated instructions

Instruction	Description	Reference
G(P).OFFGAN	Switches to the offset/gain setting mode. Switches to the normal mode.	Appendix 1.2
G(P).OGLOAD	Reads the User range settings offset/gain values to the CPU.	Appendix 1.3
G(P).OGSTOR	Restores the User range settings offset/gain values stored in the CPU to the Q68RD3-G.	Appendix 1.4

POINT

When the Q68RD3-G is mounted to a MELSECNET/H remote I/O station, the dedicated instructions cannot be used.

(2) Available devices

The following table lists the devices that can be used in the dedicated instructions.

Table APPX.2 Available devices

Internal device		File register	Constant
Bit*1	Word		
X, Y, M, L, F, V, B	T, ST, C, D, W	R, ZR	—

* 1 Word device bit specification is available for bit data.

A bit of a word device is specified with , .
(Bit number must be specified in hexadecimal.)

For example, bit 10 of D0 is specified as .

Note, however, that bit specification is not allowed for timers (T), retentive timers (ST), and counters (C).

Appendix 1.2 G(P).OFFGAN

This instruction switches the mode of the Q68RD3-G (normal mode to offset/gain setting mode, offset/gain setting mode to normal mode).

Table APPX.3 List of available devices

Setting data	Available device									
	Internal device (System, user)		File register	Link direct device J□\□		Intelligent function module device U□\G□	Index register Z□	Constant		Other
	Bit	Word		Bit	Word			K, H	\$	
(S)	—	○						—	—	—

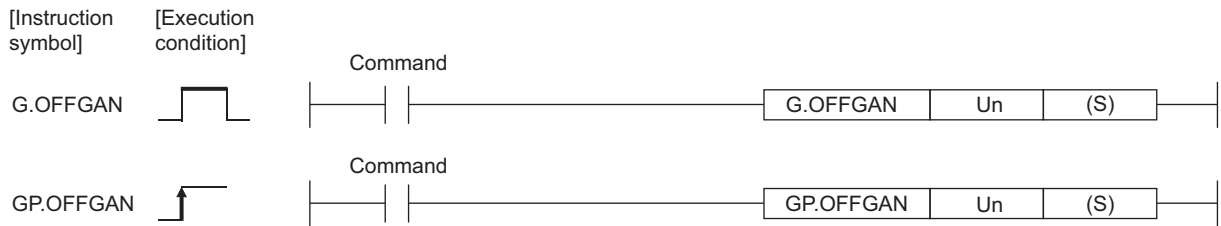

Table APPX.4 List of setting data

Setting data	Description	Setting range	Data type
Un	Start I/O number of the module	0 to FEH	16-bit binary
(S)	Mode switching 0: Switching to normal mode 1: Switching to offset/gain setting mode Any values other than above are regarded as "switching to offset/gain setting mode".	0, 1	16-bit binary

(1) Function

This instruction switches the mode of the Q68RD3-G.

- Normal mode to offset/gain setting mode (Offset/gain setting mode status flag (XA) turns ON.)
- Offset/gain setting mode to normal mode (Offset/gain setting mode status flag (XA) turns OFF.)

POINT

- (1) When the offset/gain setting mode is switched to the normal mode, Module ready (X0) turns ON.
Note that initial setting processing will be executed if there is a sequence program that performs initial setting when Module ready (X0) turns ON.
- (2) When the normal mode is switched to the offset/gain setting mode, all channels are set to "temperature conversion disable".
Set the channels where offset/gain setting will be performed to "conversion enable" and turn ON Operating condition setting request (Y9).
- (3) When the offset/gain setting mode is switched to the normal mode, restore the normal mode status prior to switching to the offset/gain setting mode and start temperature conversion.

(2) Operation error

No operation error occurs.

(3) Program example

In this program example, when M10 turns ON, the Q68RD3-G mounted in the position of I/O number X/Y0 to X/YF switches to the offset/gain setting mode. Then, the module returns to the normal mode when M10 turns OFF.

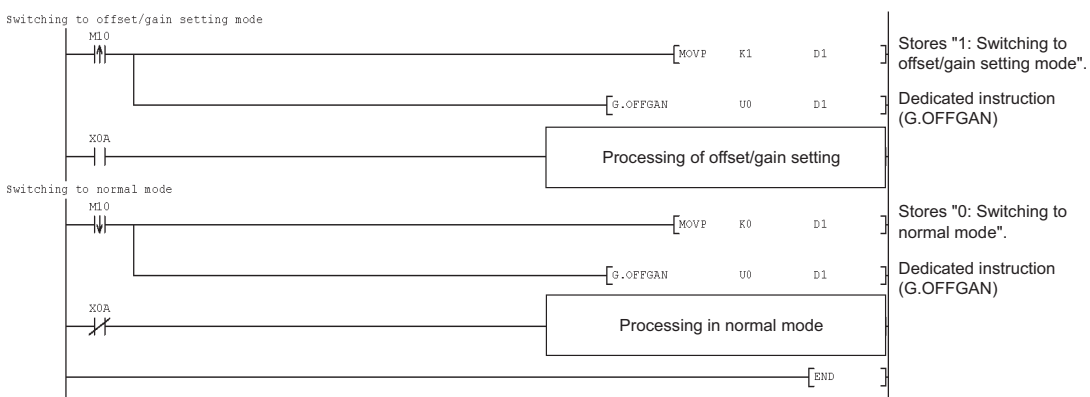

Appendix 1.3 G(P).OGLOAD

This instruction reads the User range settings offset/gain values of the Q68RD3-G to the CPU module.

Table APPX.5 List of available devices

Setting data	Available device									
	Internal device (System, user)		File register	Link direct device J□\□		Intelligent function module device U□\G□	Index register Z□	Constant		Other
	Bit	Word		Bit	Word			K, H	\$	
(S)	—	○				—		—	—	—
(D)		○				—		—	—	—

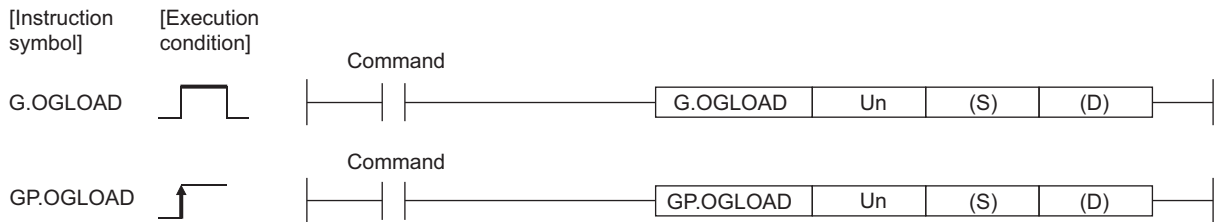

Table APPX.6 List of setting data

Setting data	Description	Setting range	Data type
Un	Start I/O number of the module	0 to FEH	16-bit binary
(S)	Start number of the device that stores control data	Within the range of the specified device	Device name
(D)	Device that turns ON for one scan upon completion of dedicated instruction processing (D)+1 also turns ON at the time of error completion.	Within the range of the specified device	Bit

Table APPX.7 Control data (1/2)*1

Device	Item	Setting data	Setting range	Setting side
(S)	System area	—	—	—
(S) + 1	Completion status	The instruction completion status is stored. 0 : Normal completion Other than 0: Error completion	—	System
(S) + 2	System area	—	—	—
(S) + 3				
(S) + 4	CH1 Factory default offset value	—	—	System
(S) + 5	CH1 Factory default gain value	—	—	System
(S) + 6	CH1 User range settings offset value	—	—	System
(S) + 7	CH1 User range settings gain value	—	—	System
(S) + 8	CH1 User range settings resistance offset value (L)	—	—	System
(S) + 9	CH1 User range settings resistance offset value (H)			
(S) + 10	CH1 User range settings resistance gain value (L)	—	—	System
(S) + 11	CH1 User range settings resistance gain value (H)			
(S) + 12	CH2 Factory default offset value	—	—	System
(S) + 13	CH2 Factory default gain value	—	—	System
(S) + 14	CH2 User range settings offset value	—	—	System
(S) + 15	CH2 User range settings gain value	—	—	System
(S) + 16	CH2 User range settings resistance offset value (L)	—	—	System
(S) + 17	CH2 User range settings resistance offset value (H)			
(S) + 18	CH2 User range settings resistance gain value (L)	—	—	System
(S) + 19	CH2 User range settings resistance gain value (H)			
(S) + 20	CH3 Factory default offset value	—	—	System
(S) + 21	CH3 Factory default gain value	—	—	System
(S) + 22	CH3 User range settings offset value	—	—	System
(S) + 23	CH3 User range settings gain value	—	—	System
(S) + 24	CH3 User range settings resistance offset value (L)	—	—	System
(S) + 25	CH3 User range settings resistance offset value (H)			
(S) + 26	CH3 User range settings resistance gain value (L)	—	—	System
(S) + 27	CH3 User range settings resistance gain value (H)			
(S) + 28	CH4 Factory default offset value	—	—	System
(S) + 29	CH4 Factory default gain value	—	—	System
(S) + 30	CH4 User range settings offset value	—	—	System
(S) + 31	CH4 User range settings gain value	—	—	System
(S) + 32	CH4 User range settings resistance offset value (L)	—	—	System
(S) + 33	CH4 User range settings resistance offset value (H)			

* 1 Setting is not necessary. If setting is made, the offset/gain values will not be read properly.

Table APPX.7 Control data (2/2)*1

Device	Item	Setting data	Setting range	Setting side
(S) + 34	CH4 User range settings resistance gain value (L)	—	—	System
(S) + 35	CH4 User range settings resistance gain value (H)			
(S) + 36	CH5 Factory default offset value	—	—	System
(S) + 37	CH5 Factory default gain value	—	—	System
(S) + 38	CH5 User range settings offset value	—	—	System
(S) + 39	CH5 User range settings gain value	—	—	System
(S) + 40	CH5 User range settings resistance offset value (L)	—	—	System
(S) + 41	CH5 User range settings resistance offset value (H)			
(S) + 42	CH5 User range settings resistance gain value (L)	—	—	System
(S) + 43	CH5 User range settings resistance gain value (H)			
(S) + 44	CH6 Factory default offset value	—	—	System
(S) + 45	CH6 Factory default gain value	—	—	System
(S) + 46	CH6 User range settings offset value	—	—	System
(S) + 47	CH6 User range settings gain value	—	—	System
(S) + 48	CH6 User range settings resistance offset value (L)	—	—	System
(S) + 49	CH6 User range settings resistance offset value (H)			
(S) + 50	CH6 User range settings resistance gain value (L)	—	—	System
(S) + 51	CH6 User range settings resistance gain value (H)			
(S) + 52	CH7 Factory default offset value	—	—	System
(S) + 53	CH7 Factory default gain value	—	—	System
(S) + 54	CH7 User range settings offset value	—	—	System
(S) + 55	CH7 User range settings gain value	—	—	System
(S) + 56	CH7 User range settings resistance offset value (L)	—	—	System
(S) + 57	CH7 User range settings resistance offset value (H)			
(S) + 58	CH7 User range settings resistance gain value (L)	—	—	System
(S) + 59	CH7 User range settings resistance gain value (H)			
(S) + 60	CH8 Factory default offset value	—	—	System
(S) + 61	CH8 Factory default gain value	—	—	System
(S) + 62	CH8 User range settings offset value	—	—	System
(S) + 63	CH8 User range settings gain value	—	—	System
(S) + 64	CH8 User range settings resistance offset value (L)	—	—	System
(S) + 65	CH8 User range settings resistance offset value (H)			
(S) + 66	CH8 User range settings resistance gain value (L)	—	—	System
(S) + 67	CH8 User range settings resistance gain value (H)			

* 1 Setting is not necessary. If setting is made, the offset/gain values will not be read properly.

(1) Function

- (a) This instruction reads the User range settings offset/gain values of the Q68RD3-G to the CPU module.
- (b) There are two types of interlock signals for the G(P).OGLOAD instruction: the completion device (D) and the completion status indication device (D)+1.
 - 1) Completion device
Turns ON in the END processing of the scan where the G(P).OGLOAD instruction is completed, and turns OFF in the next END processing.
 - 2) Completion status indication device
Turns ON and OFF depending on the completion status of the G(P).OGLOAD instruction.
 - Normal completion : Remains OFF.
 - Error completion : Turns ON in the END processing of the scan where the G(P).OGLOAD instruction is completed, and turns OFF in the next END processing.

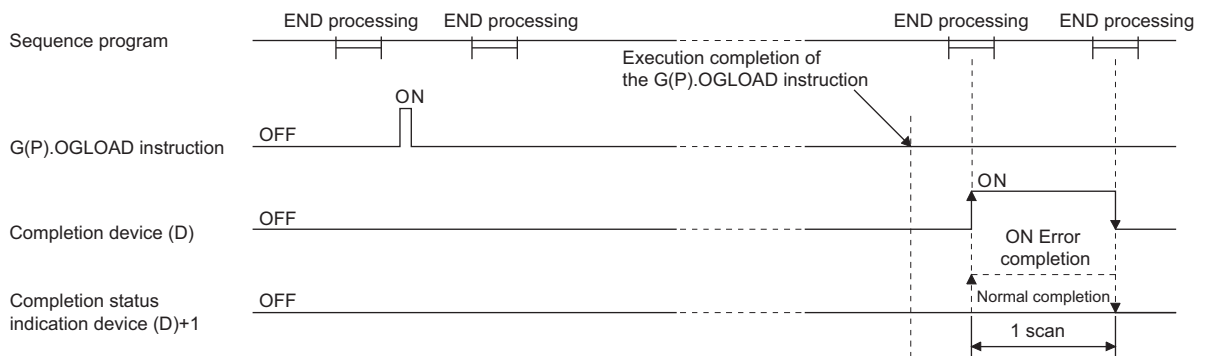

(2) Operation error

No operation error occurs.

(3) Program example

In this program example, when M11 turns ON, the offset/gain values of the Q68RD3-G mounted in the position of I/O number X/Y0 to X/YF are read to the CPU module.

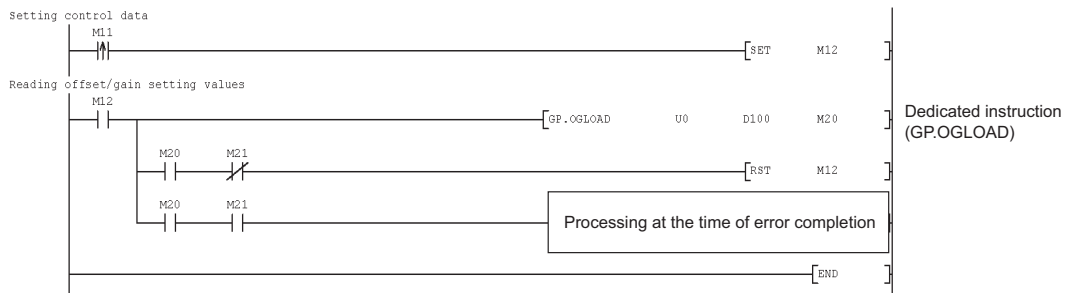

Appendix 1.4 G(P).OGSTOR

This instruction restores the User range settings offset/gain values stored in the CPU module to the Q68RD3-G.

Table APPX.8 List of available devices

Setting data	Available device									
	Internal device (System, user)		File register	Link direct device J□\□		Intelligent function module device U□\G□	Index register Z□	Constant		Other
	Bit	Word		Bit	Word			K, H	\$	
(S)	—	○				—		—	—	—
(D)		○				—		—	—	—

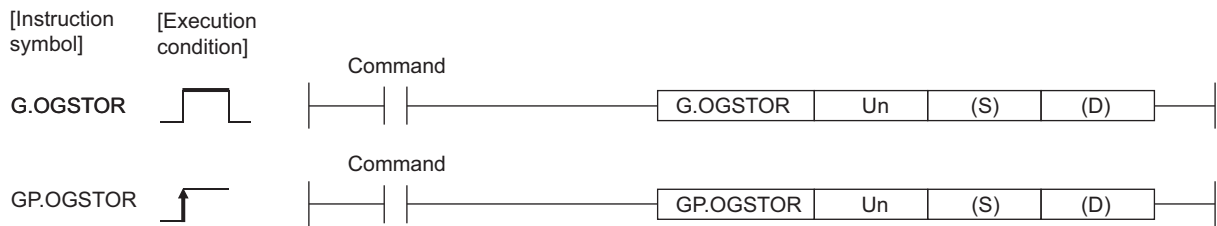

Table APPX.9 List of setting data

Setting data	Description	Setting range	Data type
Un	Start I/O number of the module	0 to FEH	16-bit binary
(S) ^{*1}	Start number of the device that stores control data	Within the range of the specified device	Device name
(D)	Device that turns ON for one scan upon completion of dedicated instruction processing (D)+1 also turns ON at the time of error completion.	Within the range of the specified device	Bit

* 1 When executing the G(P).OGLOAD instruction, specify the device set for (S).
Do not change the data read with the G(P).OGLOAD instruction.
If it is changed, normal operation cannot be guaranteed.

Table APPX.10 Control data (1/2)

Device	Item	Setting data	Setting range	Setting side
(S)	System area	—	—	—
(S) + 1	Completion status	The instruction completion status is stored. 0 : Normal completion Other than 0: Error completion	—	System
(S) + 2	System area	—	—	—
(S) + 3				
(S) + 4	CH1 Factory default offset value	—	—	System
(S) + 5	CH1 Factory default gain value	—	—	System
(S) + 6	CH1 User range settings offset value	—	—	System
(S) + 7	CH1 User range settings gain value	—	—	System
(S) + 8	CH1 User range settings resistance offset value (L)	—	—	System
(S) + 9	CH1 User range settings resistance offset value (H)			
(S) + 10	CH1 User range settings resistance gain value (L)	—	—	System
(S) + 11	CH1 User range settings resistance gain value (H)			
(S) + 12	CH2 Factory default offset value	—	—	System
(S) + 13	CH2 Factory default gain value	—	—	System
(S) + 14	CH2 User range settings offset value	—	—	System
(S) + 15	CH2 User range settings gain value	—	—	System
(S) + 16	CH2 User range settings resistance offset value (L)	—	—	System
(S) + 17	CH2 User range settings resistance offset value (H)			
(S) + 18	CH2 User range settings resistance gain value (L)	—	—	System
(S) + 19	CH2 User range settings resistance gain value (H)			
(S) + 20	CH3 Factory default offset value	—	—	System
(S) + 21	CH3 Factory default gain value	—	—	System
(S) + 22	CH3 User range settings offset value	—	—	System
(S) + 23	CH3 User range settings gain value	—	—	System
(S) + 24	CH3 User range settings resistance offset value (L)	—	—	System
(S) + 25	CH3 User range settings resistance offset value (H)			
(S) + 26	CH3 User range settings resistance gain value (L)	—	—	System
(S) + 27	CH3 User range settings resistance gain value (H)			
(S) + 28	CH4 Factory default offset value	—	—	System
(S) + 29	CH4 Factory default gain value	—	—	System
(S) + 30	CH4 User range settings offset value	—	—	System
(S) + 31	CH4 User range settings gain value	—	—	System
(S) + 32	CH4 User range settings resistance offset value (L)	—	—	System
(S) + 33	CH4 User range settings resistance offset value (H)			

Table APPX.10 Control data (2/2)

Device	Item	Setting data	Setting range	Setting side
(S) + 34	CH4 User range settings resistance gain value (L)	—	—	System
(S) + 35	CH4 User range settings resistance gain value (H)			
(S) + 36	CH5 Factory default offset value	—	—	System
(S) + 37	CH5 Factory default gain value	—	—	System
(S) + 38	CH5 User range settings offset value	—	—	System
(S) + 39	CH5 User range settings gain value	—	—	System
(S) + 40	CH5 User range settings resistance offset value (L)	—	—	System
(S) + 41	CH5 User range settings resistance offset value (H)			
(S) + 42	CH5 User range settings resistance gain value (L)	—	—	System
(S) + 43	CH5 User range settings resistance gain value (H)			
(S) + 44	CH6 Factory default offset value	—	—	System
(S) + 45	CH6 Factory default gain value	—	—	System
(S) + 46	CH6 User range settings offset value	—	—	System
(S) + 47	CH6 User range settings gain value	—	—	System
(S) + 48	CH6 User range settings resistance offset value (L)	—	—	System
(S) + 49	CH6 User range settings resistance offset value (H)			
(S) + 50	CH6 User range settings resistance gain value (L)	—	—	System
(S) + 51	CH6 User range settings resistance gain value (H)			
(S) + 52	CH7 Factory default offset value	—	—	System
(S) + 53	CH7 Factory default gain value	—	—	System
(S) + 54	CH7 User range settings offset value	—	—	System
(S) + 55	CH7 User range settings gain value	—	—	System
(S) + 56	CH7 User range settings resistance offset value (L)	—	—	System
(S) + 57	CH7 User range settings resistance offset value (H)			
(S) + 58	CH7 User range settings resistance gain value (L)	—	—	System
(S) + 59	CH7 User range settings resistance gain value (H)			
(S) + 60	CH8 Factory default offset value	—	—	System
(S) + 61	CH8 Factory default gain value	—	—	System
(S) + 62	CH8 User range settings offset value	—	—	System
(S) + 63	CH8 User range settings gain value	—	—	System
(S) + 64	CH8 User range settings resistance offset value (L)	—	—	System
(S) + 65	CH8 User range settings resistance offset value (H)			
(S) + 66	CH8 User range settings resistance gain value (L)	—	—	System
(S) + 67	CH8 User range settings resistance gain value (H)			

(1) Function

- (a) This instruction restores the User range settings offset/gain values stored in the CPU module to the Q68RD3-G.
- (b) There are two types of interlock signals for the G(P).OGSTOR instruction: the completion device (D) and the completion status indication device (D)+1.
 - 1) Completion device
Turns ON in the END processing of the scan where the G(P).OGSTOR instruction is completed, and turns OFF in the next END processing.
 - 2) Completion status indication device
Turns ON and OFF depending on the completion status of the G(P).OGSTOR instruction.
 - Normal completion : Remains OFF.
 - Error completion : Turns ON in the END processing of the scan where the G(P).OGLOAD instruction is completed, and turns OFF in the next END processing.

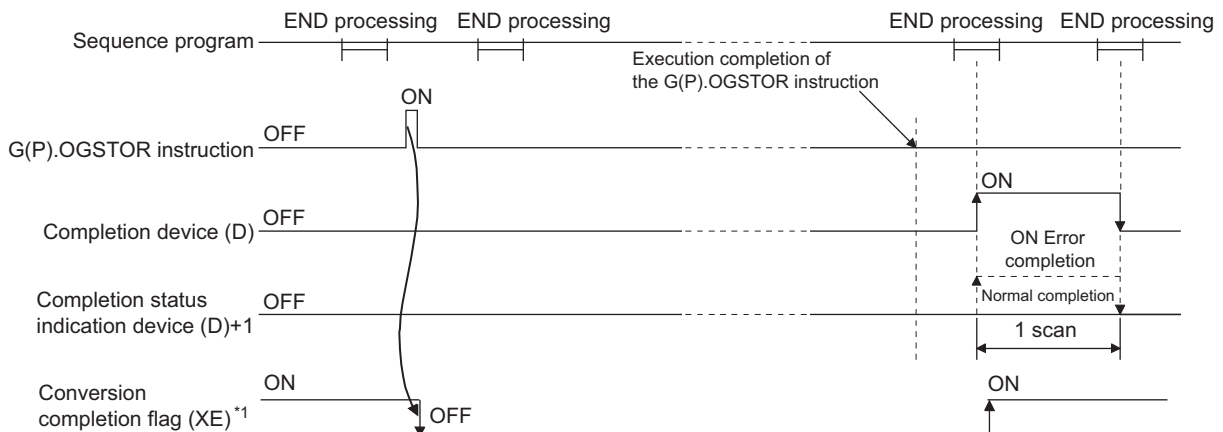

* 1 When the G(P).OGSTOR instruction is executed, conversion is not performed. After the completion device (D) turns ON, conversion starts. Then, after the conversion value is stored into the buffer memory, Conversion completion flag (XE) turns ON.

- (c) When the offset/gain values are restored, the reference accuracy falls to about less than 1/3 times of the previous accuracy.

(2) Operation error

An error occurs in any of the following cases and the corresponding error code is stored into the completion status area (S)+1.

Table APPX.11 List of errors

Error code	Description
161	The G(P).OGSTOR instruction was executed in the offset/gain setting mode.
162	The G(P).OGSTOR instruction was executed consecutively.
163	The G(P).OGSTOR instruction was executed for the model that differs from the model for which the G(P).OGLOAD instruction had been executed.

(3) Program example

In this program example, when M11 turns ON, the offset/gain values are restored to the Q68RD3-G mounted in the position of I/O number X/Y10 to X/Y1F.

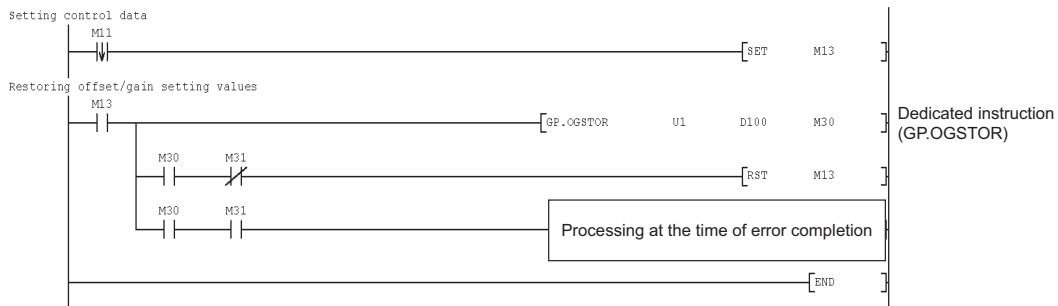

Appendix 2 External Dimensions

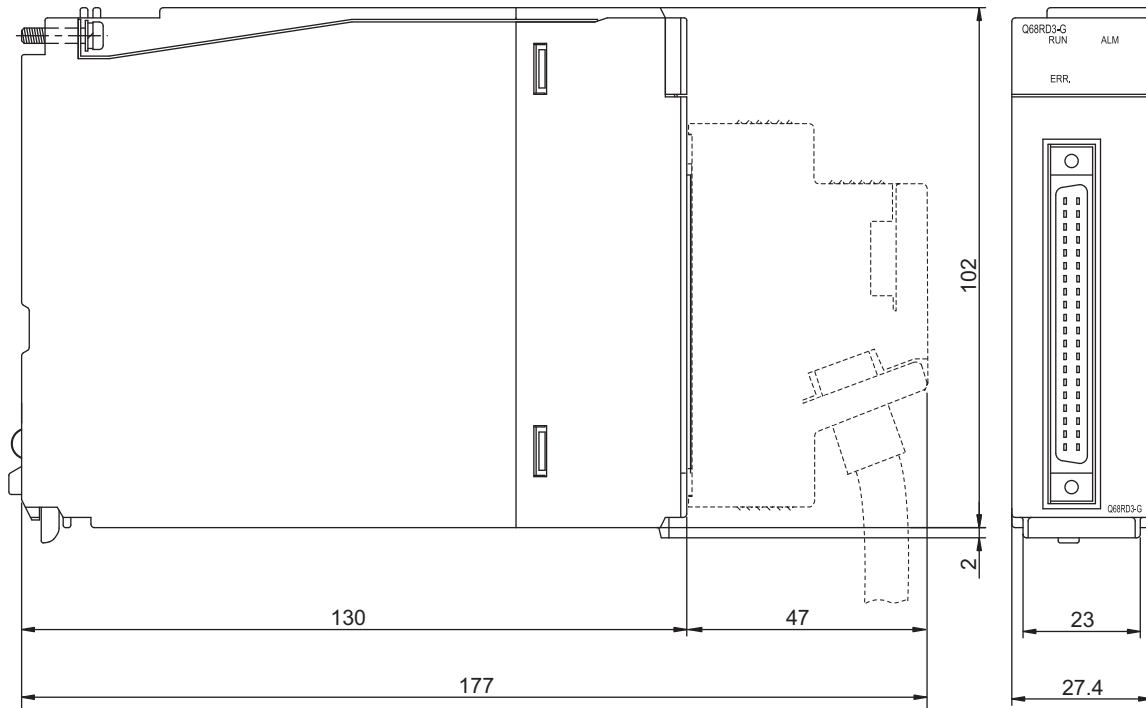

Unit: mm

INDEX

[A]

ALM LED	4-4
Auto refresh setting	5-17
Averaging processing	3-5
Averaging processing selection	3-35

[B]

Buffer memory	3-24
---------------------	------

[C]

Channel change completion flag	3-20
Channel change request	3-23
Connector/terminal block converter module	4-8
Conversion accuracy	3-1
Conversion completion flag	3-21,3-32
Conversion enable/disable function	3-3
Conversion enable/disable setting	3-30
Conversion setting for disconnection detection ...	3-47
Conversion setting for disconnection detection function	3-3,3-9
Conversion setting value for disconnection detection	3-48
Count average	3-5

[D]

Dedicated instructions	APPX-1
Disconnection detection flag	3-39
Disconnection detection function	3-3
Disconnection detection signal	3-20
Down scale	A-14,3-9

[E]

EMC and Low Voltage Directives	A-13,4-6
Error clear request	3-23
Error code	3-34
Error Code List	8-1
Error flag	3-22
ERR. LED	4-4
External dimensions	APPX-13
External wiring	4-7

[F]

Factory default offset/gain values, user range settings offset/gain values, user range settings resistance offset/gain values	3-49
---	------

[G]

GX Configurator-TI	2-2,5-1
GX Developer	2-2
G(P).OFFGAN	APPX-2
G(P).OGLOAD	APPX-4
G(P).OGSTOR	APPX-8

[H]

Handling Precautions	4-1
H/W Information	8-7

[I]

Initial setting	5-15
Installing and uninstalling	5-3
Intelligent function module parameters	5-9
Intelligent function module switch setting	4-9
I/O Signals	3-17

[M]

Measured temperature value	3-33
Measurement range setting	4-9
Mode switching setting	3-46
Module fixing bracket	4-2
Module ready	3-18
Monitor/test	5-19
Moving average	3-6

[O]

Offset/gain setting	4-11,5-19
Offset/gain setting mode	3-36
Offset/gain setting mode status flag	3-19
Offset/gain temperature setting values	3-37
Online module change	7-1
Operating condition setting request	3-22
Operating environment	5-6
Operation condition setting completion flag	3-18

[P]

Part names	4-4
Primary delay filter	3-7
Procedures and Settings before System Operation	4-3
Process alarm	3-11
Process alarm upper/lower limit values	3-44
Programming	6-1

[Q]

QCPU (Q mode)	A-14
Q68RD3-G	A-14

[R]

Rate alarm	3-13
Rate alarm upper/lower limit values	3-45
Rate alarm warning detection period	3-45
Read from PLC	5-14
RTD type selection function, Range switching function	3-3
RUN LED	4-4

[S]

Sampling processing	3-5
Scaling function	3-3
Scaling range upper/lower limit values	3-43
Scaling valid/invalid setting	3-42
Scaling value	3-41
Scaling width upper/lower limit values	3-43
Setting range	3-34

[T]

Temperature conversion function	3-3
Temperature conversion system	3-3,3-4
Text files	5-10
Time average	3-5
Time/count/moving average/time constant setting	3-31
Troubleshooting	8-3

[U]

Up scale	A-14,3-9
User range write request	3-23

[W]

Warning output enable/disable setting	3-37
Warning output flag	3-38
Warning output function	3-3,3-11
Warning output signal	3-20
Wiring precautions	4-6
Write to PLC	5-14

WARRANTY

Please confirm the following product warranty details before using this product.

1. Gratis Warranty Term and Gratis Warranty Range

If any faults or defects (hereinafter "Failure") found to be the responsibility of Mitsubishi occurs during use of the product within the gratis warranty term, the product shall be repaired at no cost via the sales representative or Mitsubishi Service Company.

However, if repairs are required onsite at domestic or overseas location, expenses to send an engineer will be solely at the customer's discretion. Mitsubishi shall not be held responsible for any re-commissioning, maintenance, or testing on-site that involves replacement of the failed module.

[Gratis Warranty Term]

The gratis warranty term of the product shall be for one year after the date of purchase or delivery to a designated place. Note that after manufacture and shipment from Mitsubishi, the maximum distribution period shall be six (6) months, and the longest gratis warranty term after manufacturing shall be eighteen (18) months. The gratis warranty term of repair parts shall not exceed the gratis warranty term before repairs.

[Gratis Warranty Range]

- (1) The range shall be limited to normal use within the usage state, usage methods and usage environment, etc., which follow the conditions and precautions, etc., given in the instruction manual, user's manual and caution labels on the product.
- (2) Even within the gratis warranty term, repairs shall be charged for in the following cases.
 1. Failure occurring from inappropriate storage or handling, carelessness or negligence by the user. Failure caused by the user's hardware or software design.
 2. Failure caused by unapproved modifications, etc., to the product by the user.
 3. When the Mitsubishi product is assembled into a user's device, Failure that could have been avoided if functions or structures, judged as necessary in the legal safety measures the user's device is subject to or as necessary by industry standards, had been provided.
 4. Failure that could have been avoided if consumable parts (battery, backlight, fuse, etc.) designated in the instruction manual had been correctly serviced or replaced.
 5. Failure caused by external irresistible forces such as fires or abnormal voltages, and Failure caused by force majeure such as earthquakes, lightning, wind and water damage.
 6. Failure caused by reasons unpredictable by scientific technology standards at time of shipment from Mitsubishi.
 7. Any other failure found not to be the responsibility of Mitsubishi or that admitted not to be so by the user.

2. Onerous repair term after discontinuation of production

- (1) Mitsubishi shall accept onerous product repairs for seven (7) years after production of the product is discontinued. Discontinuation of production shall be notified with Mitsubishi Technical Bulletins, etc.
- (2) Product supply (including repair parts) is not available after production is discontinued.

3. Overseas service

Overseas, repairs shall be accepted by Mitsubishi's local overseas FA Center. Note that the repair conditions at each FA Center may differ.

4. Exclusion of loss in opportunity and secondary loss from warranty liability

Regardless of the gratis warranty term, Mitsubishi shall not be liable for compensation to:

- (1) Damages caused by any cause found not to be the responsibility of Mitsubishi.
- (2) Loss in opportunity, lost profits incurred to the user by Failures of Mitsubishi products.
- (3) Special damages and secondary damages whether foreseeable or not, compensation for accidents, and compensation for damages to products other than Mitsubishi products.
- (4) Replacement by the user, maintenance of on-site equipment, start-up test run and other tasks.

5. Changes in product specifications

The specifications given in the catalogs, manuals or technical documents are subject to change without prior notice.

Microsoft, Windows, Windows Vista, Windows NT, Windows XP, Windows Server, Visio, Excel, PowerPoint, Visual Basic, Visual C++, and Access are either registered trademarks or trademarks of Microsoft Corporation in the United States, Japan, and other countries.

Intel, Pentium, and Celeron are either registered trademarks or trademarks of Intel Corporation in the United States and other countries.

Ethernet is a trademark of Xerox Corp.

All other company names and product names used in this manual are either trademarks or registered trademarks of their respective companies.

SH(NA)-080722ENG-E(1606)MEE

MODEL: Q68RD3-G-U-SY-E

MODEL CODE: 13JZ06

MITSUBISHI ELECTRIC CORPORATION

HEAD OFFICE : TOKYO BUILDING, 2-7-3 MARUNOUCHI, CHIYODA-KU, TOKYO 100-8310, JAPAN
NAGOYA WORKS : 1-14, YADA-MINAMI 5-CHOME, HIGASHI-KU, NAGOYA, JAPAN

When exported from Japan, this manual does not require application to the
Ministry of Economy, Trade and Industry for service transaction permission.

Specifications subject to change without notice.